

The Higgs boson is found: What is next?

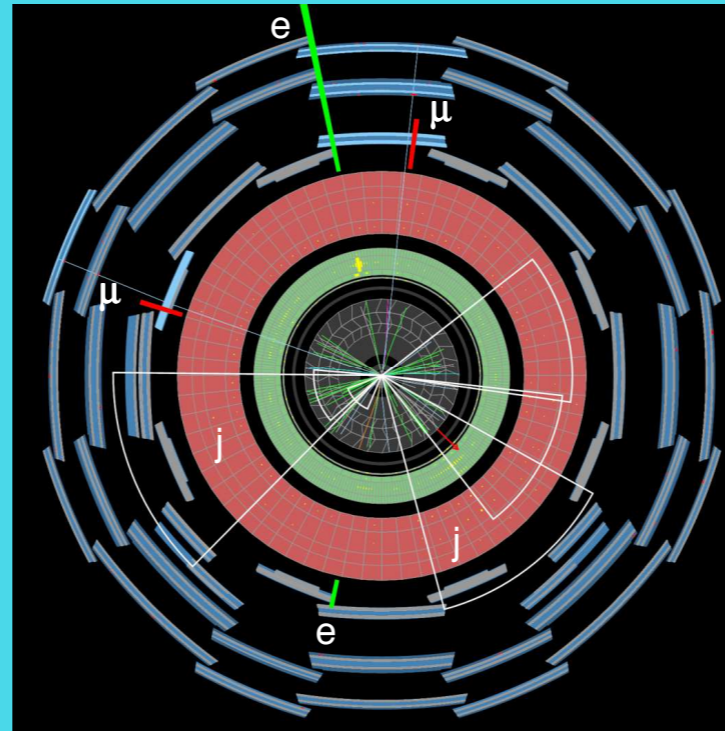

Dmitry Kazakov

Bogoliubov Laboratory of Theoretical Physics
Joint Institute for Nuclear Research (Dubna)

Moscow Institute of Physics and Technology

Round table «What Next».

4 March 2014



The Standard Model

SU(3)

SU(2)

U(1)

Standard Model

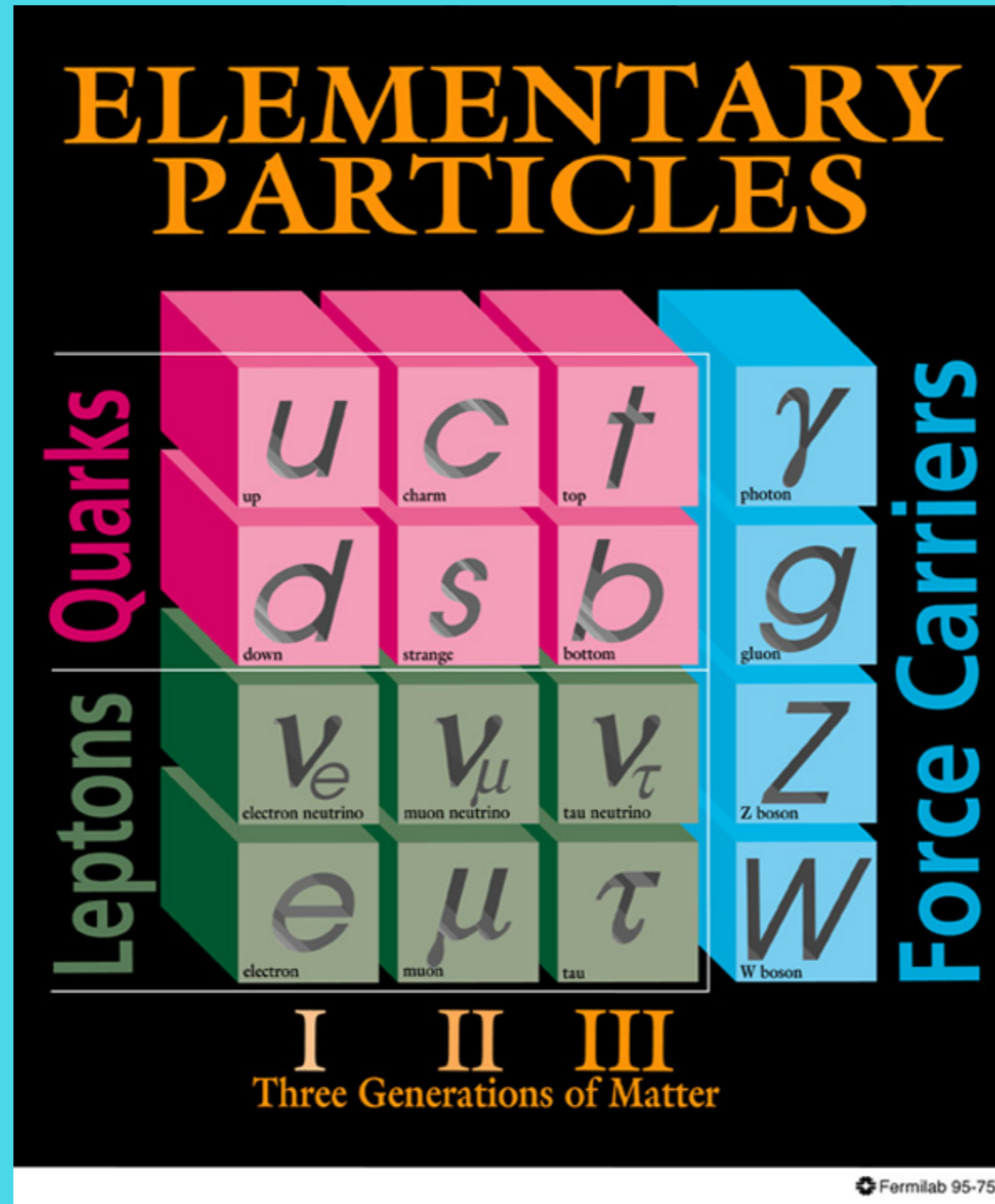

U(1)

The Higgs boson

Gravity

The Standard Model

SU(3)

SU(2)

U(1)

Standard Model

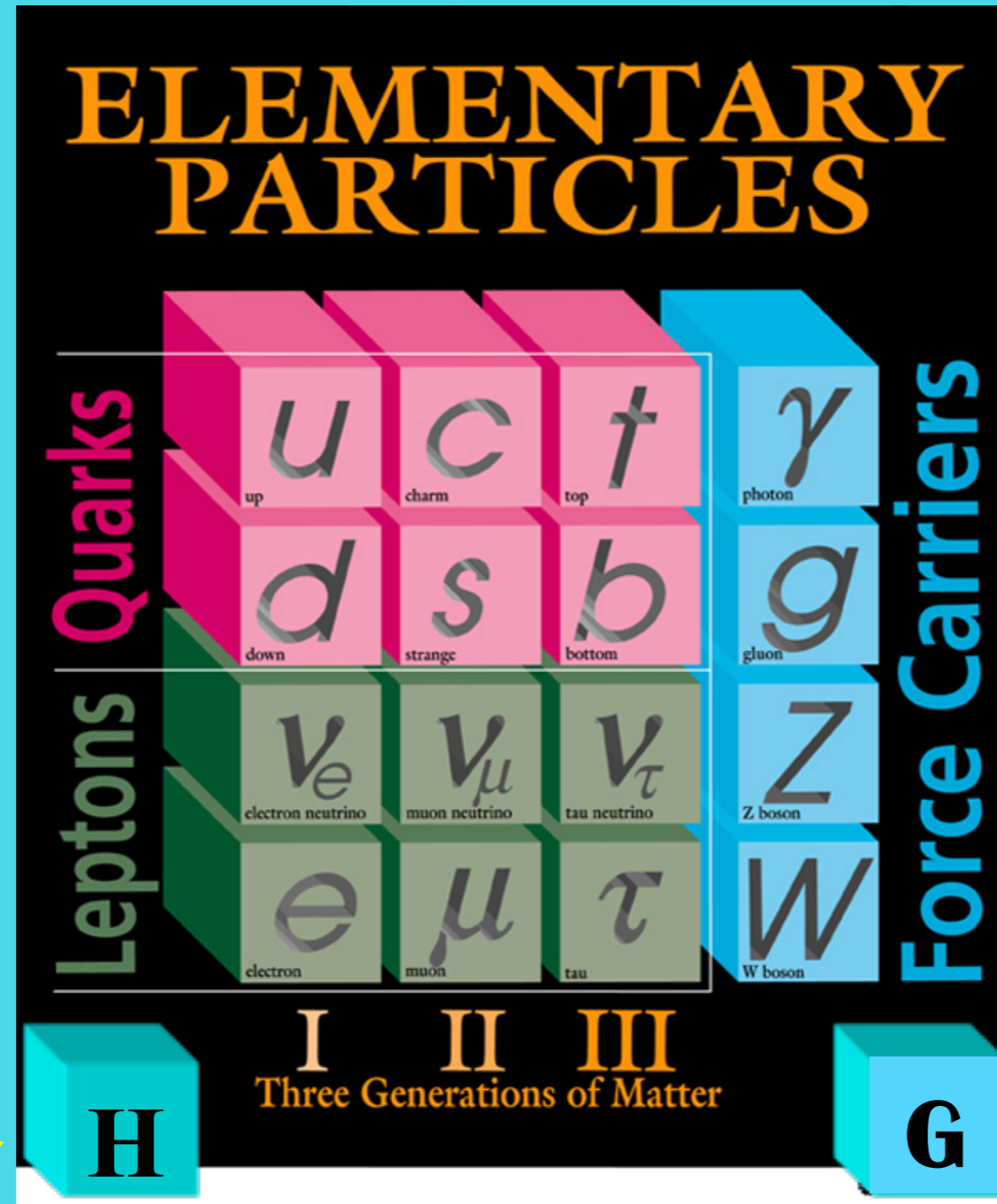

The Higgs boson



Gravity

The Standard Model

The Standard Model

 **The Standard Model** of strong, weak and electromagnetic interactions describes quantitatively practically all existing data!

The Standard Model

-  **The Standard Model** of strong, weak and electromagnetic interactions describes quantitatively practically all existing data!
-  Neutrino oscillations require (probably) just minor modifications of the model.

The Standard Model

- 🌐 **The Standard Model** of strong, weak and electromagnetic interactions describes quantitatively practically all existing data!
- 🌐 Neutrino oscillations require (probably) just minor modifications of the model.
- 🌐 There are **5** fundamental forces of Nature with carriers having spin 0, 1 and 2!

The Standard Model

- **The Standard Model** of strong, weak and electromagnetic interactions describes quantitatively practically all existing data!
- Neutrino oscillations require (probably) just minor modifications of the model.
- There are **5** fundamental forces of Nature with carriers having spin 0, 1 and 2!
- New precision measurements of flavour changing processes and the processes with CP violation passed all tests!

The Standard Model

- 🌐 **The Standard Model** of strong, weak and electromagnetic interactions describes quantitatively practically all existing data!
- 🌐 Neutrino oscillations require (probably) just minor modifications of the model.
- 🌐 There are **5** fundamental forces of Nature with carriers having spin 0, 1 and 2!
- 🌐 New precision measurements of flavour changing processes and the processes with CP violation passed all tests!

Is it the end of a story or a step forward?

The Standard Model

- **The Standard Model** of strong, weak and electromagnetic interactions describes quantitatively practically all existing data!
- Neutrino oscillations require (probably) just minor modifications of the model.
- There are **5** fundamental forces of Nature with carriers having spin 0, 1 and 2!
- New precision measurements of flavour changing processes and the processes with CP violation passed all tests!

Is it the end of a story or a step forward?

- This is the beginning of a new research program with decades to go.

The Standard Model of Fundamental Interactions

Higgs Sector

Neutrino Sector

Flavour Sector

Dark Matter

New particles and Interactions

The Higgs Sector

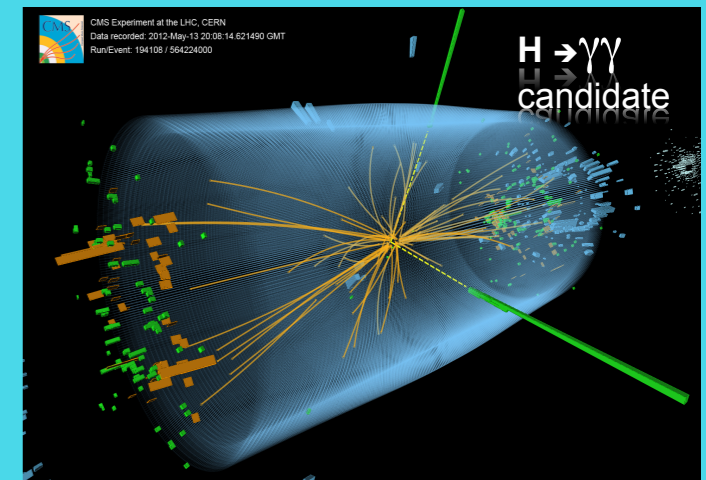

The Higgs Sector

- Is it the Higgs boson? - Almost sure

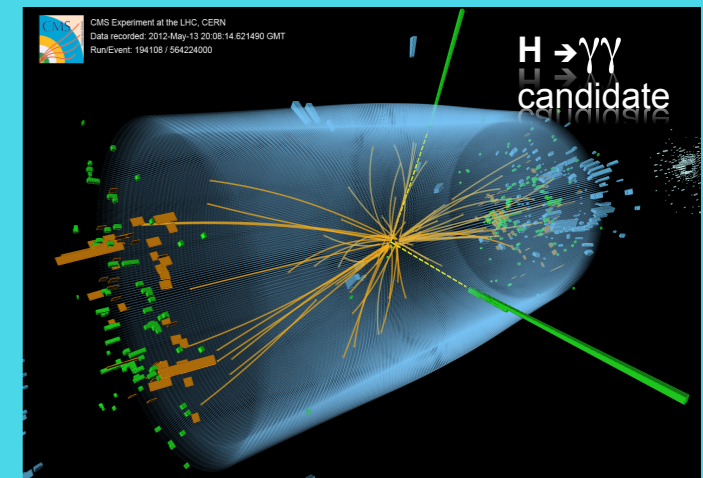

The Higgs Sector

- Is it the Higgs boson? - Almost sure
- Is it the Higgs boson of the Standard Model? - It seems so

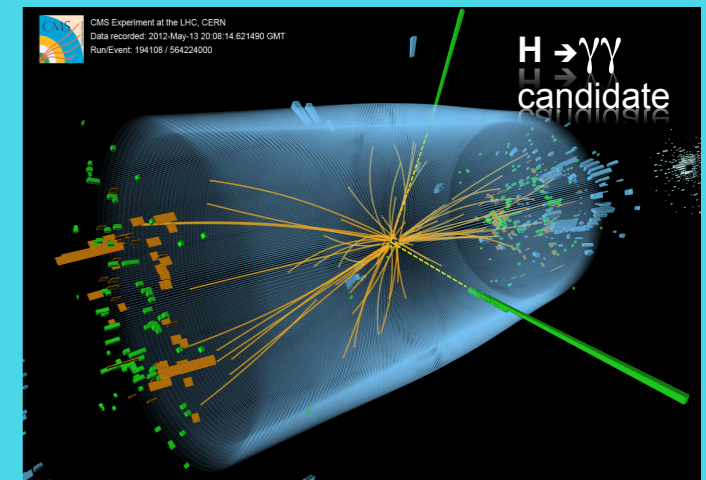

The Higgs Sector

- Is it the Higgs boson? - Almost sure
- Is it the Higgs boson of the Standard Model? - It seems so
- Are there alternatives? - Yes

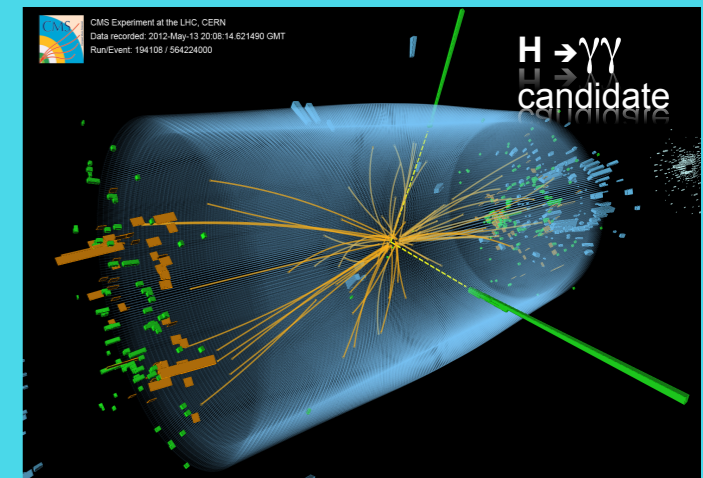

The Higgs Sector

- Is it the Higgs boson? - Almost sure
- Is it the Higgs boson of the Standard Model? - It seems so
- Are there alternatives? - Yes
- Can it be that we see more than one Higgs boson? - May be

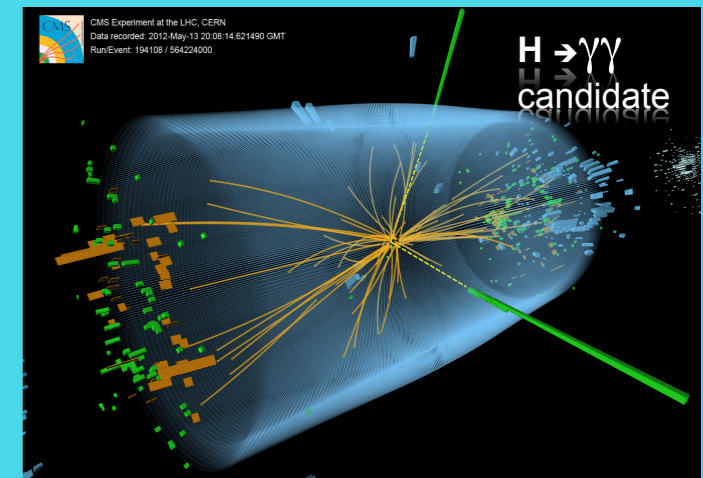

The Higgs Sector

- Is it the Higgs boson? - Almost sure
- Is it the Higgs boson of the Standard Model? - It seems so
- Are there alternatives? - Yes
- Can it be that we see more than one Higgs boson? - May be
- Can one get confident answers to these questions? - Yes

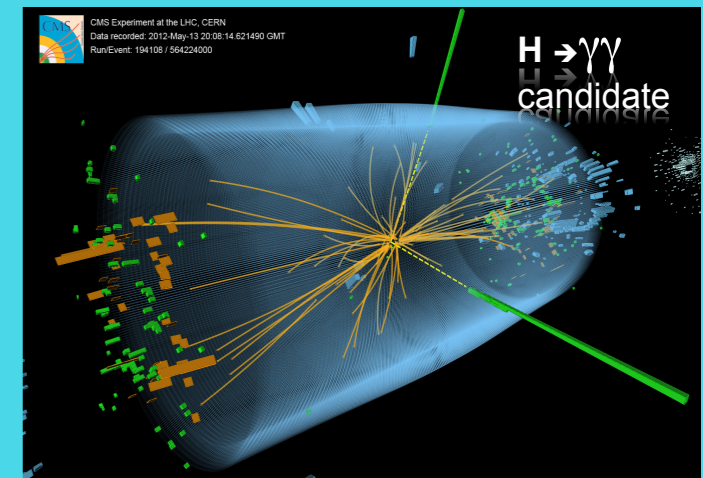

The Higgs Sector

- Is it the Higgs boson? - Almost sure
- Is it the Higgs boson of the Standard Model? - It seems so
- Are there alternatives? - Yes
- Can it be that we see more than one Higgs boson? - May be
- Can one get confident answers to these questions? - Yes

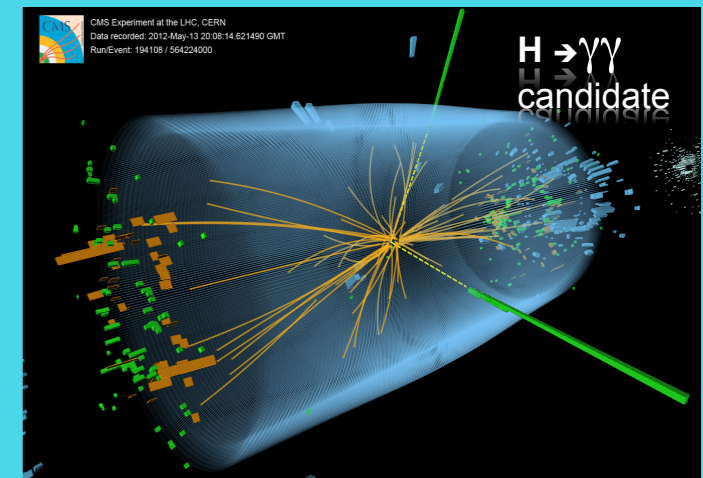

New experiments at the LHC at doubled energy and at new accelerators (if built) will allow one to answer these questions with enough precision

The Higgs Sector

- Is it the Higgs boson? - Almost sure
- Is it the Higgs boson of the Standard Model? - It seems so
- Are there alternatives? - Yes
- Can it be that we see more than one Higgs boson? - May be
- Can one get confident answers to these questions? - Yes

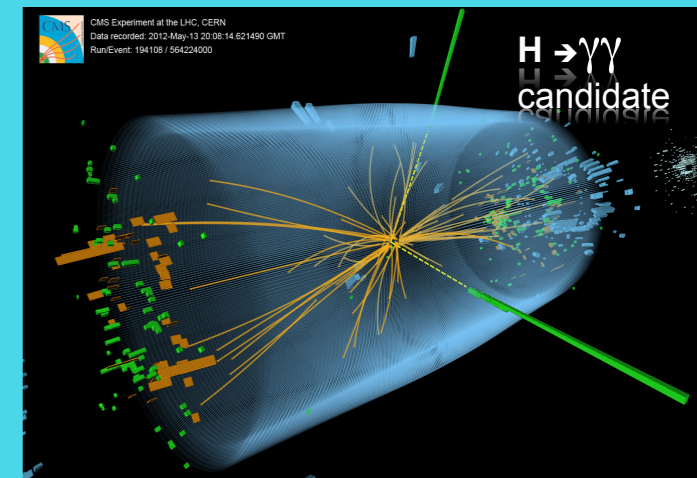

New experiments at the LHC at doubled energy and at new accelerators (if built) will allow one to answer these questions with enough precision

We have got the confirmation that particles obtain their masses as a result of interaction with the Brout-Englert-Higgs field (whatever model the Higgs boson belongs to)

The Higgs Sector: Alternatives

Model	Particle content
SM	h CP-even
2HDM/MSSM	h, H CP-even A CP-odd H^{\pm}
NMSSM	H_1, H_2, H_3 CP-even A_1, A_2 CP-odd H^{\pm}
Composite	h CP-even + excited states

The Higgs Sector: Alternatives

Model	Particle content
SM	h CP-even
2HDM/MSSM	h, H CP-even A CP-odd H^\pm
NMSSM	H_1, H_2, H_3 CP-even A_1, A_2 CP-odd H^\pm
Composite	h CP-even + excited states

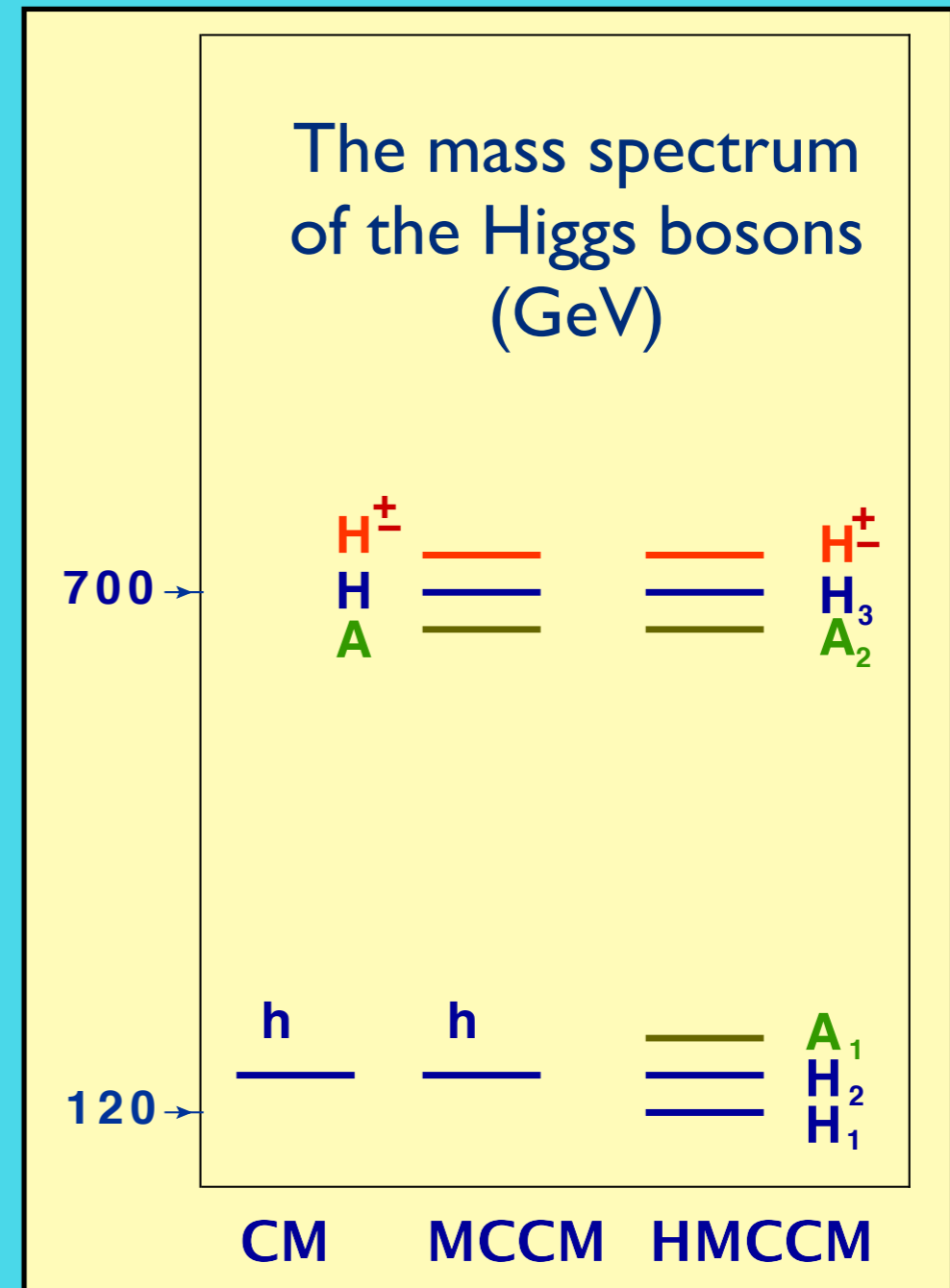

The Higgs Sector: Alternatives

Model	Particle content
SM	h CP-even
2HDM/MSSM	h, H CP-even A CP-odd H^\pm
NMSSM	H_1, H_2, H_3 CP-even A_1, A_2 CP-odd H^\pm
Composite	h CP-even + excited states

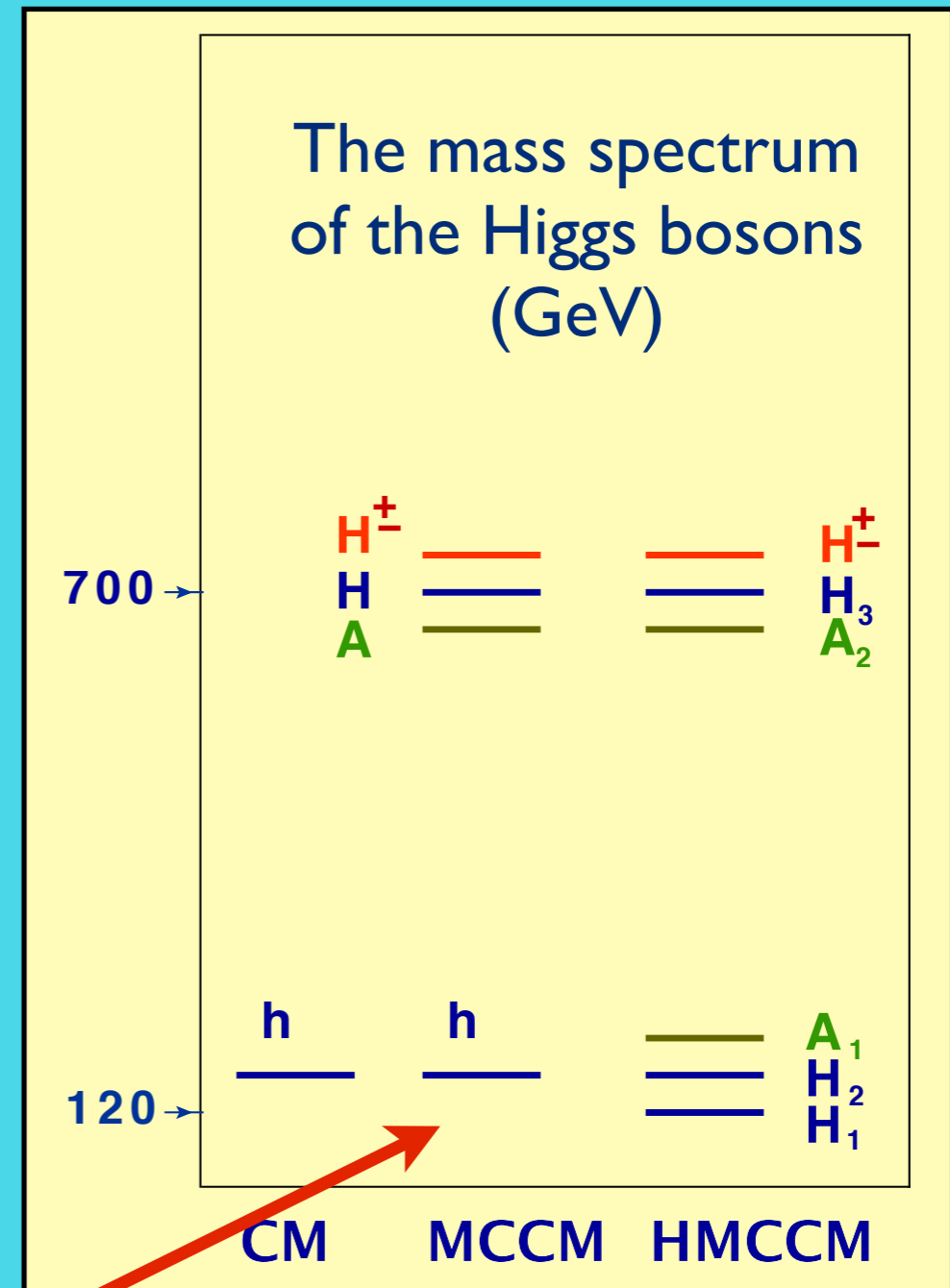

It may well be that we see one of these states

The Higgs Sector: Alternatives

Model	Particle content
SM	h CP-even
2HDM/MSSM	h, H CP-even A CP-odd H^\pm
NMSSM	H_1, H_2, H_3 CP-even A_1, A_2 CP-odd H^\pm
Composite	h CP-even + excited states

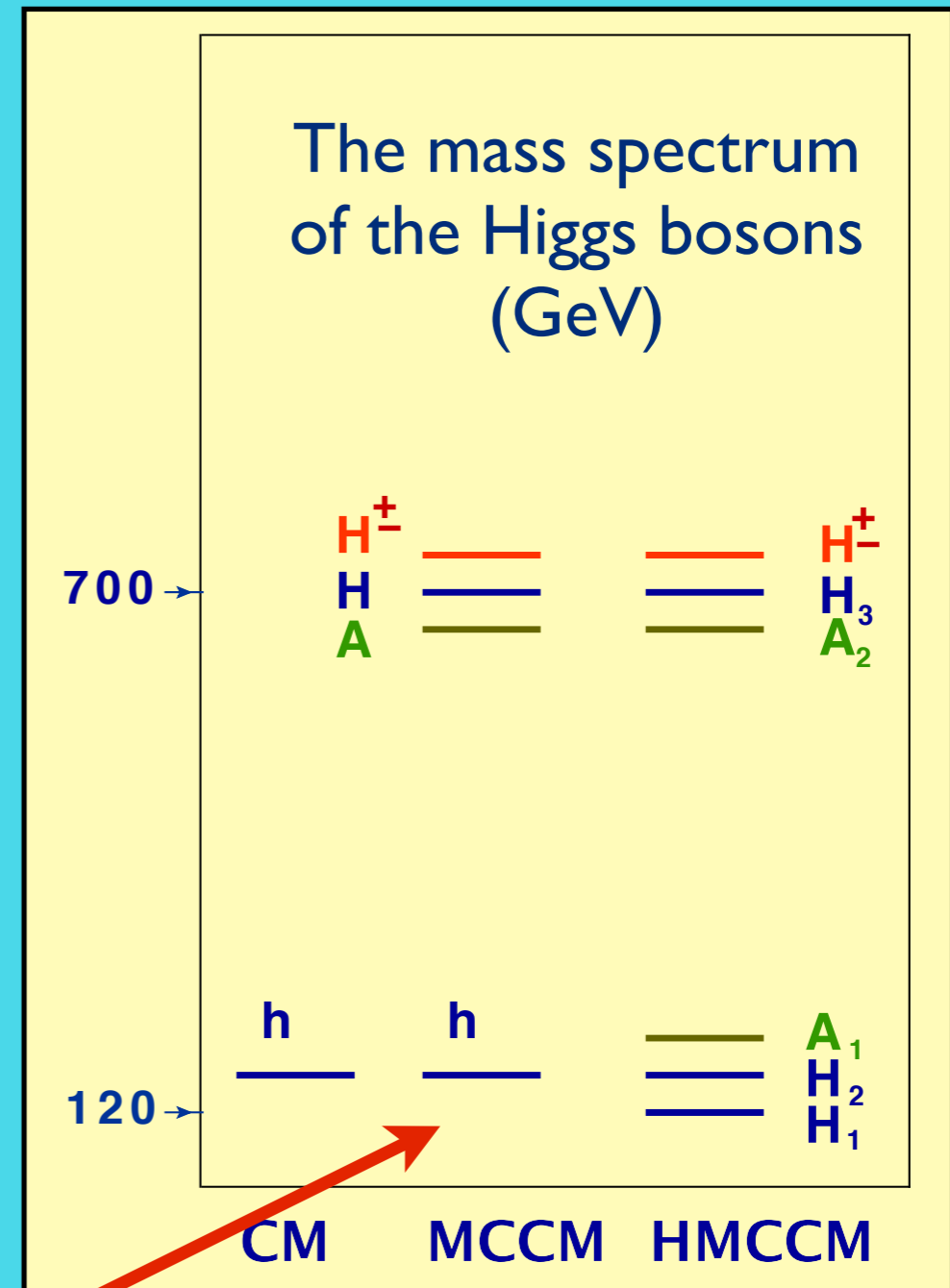

It may well be that we see one of these states

One has to check the presence or absence of heavy Higgs bosons

Precision Physics of the Higgs bosons

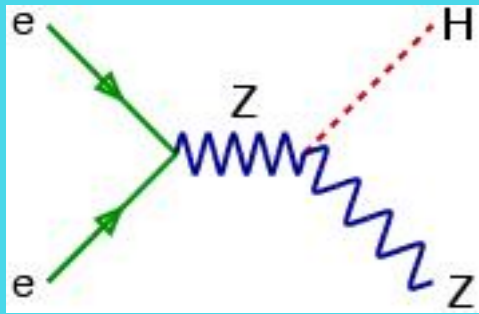

$\rightarrow b\bar{b}q\bar{q}$

$ee \rightarrow HZ$ diff. decay channels

$\rightarrow W^+W^-q\bar{q}$

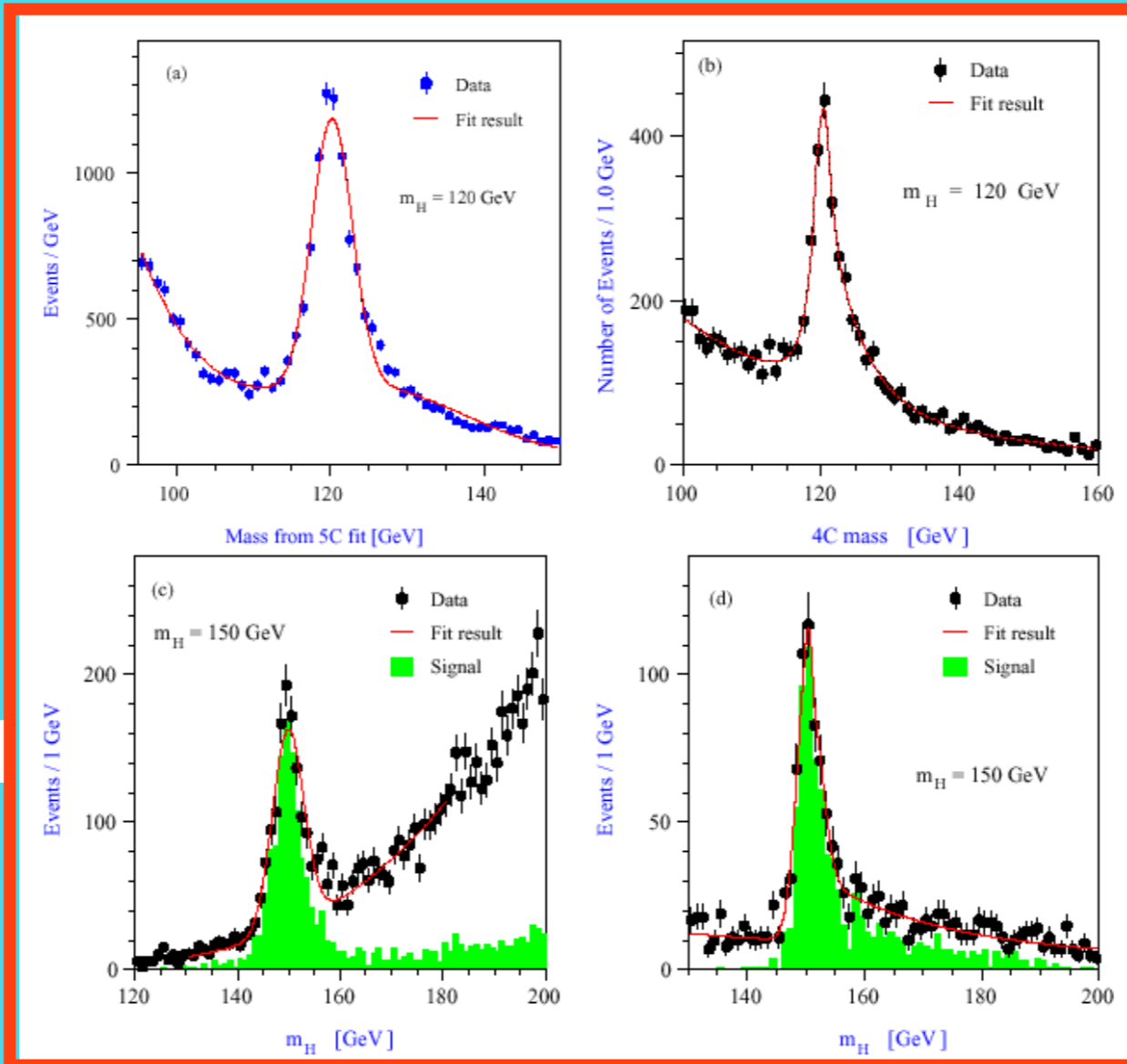

$\rightarrow q\bar{q}l^+l^-$

$\Delta m_H = 40 \text{ MeV}$

$\rightarrow W^+W^-l^+l^-$

$\Delta m_H = 70 \text{ MeV}$

Precision Physics of the Higgs bosons

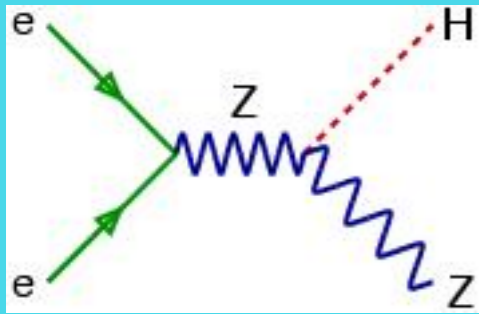

$\rightarrow b\bar{b}q\bar{q}$

$ee \rightarrow HZ$ diff. decay channels

Int Linear Collider

$\rightarrow W^+W^-q\bar{q}$

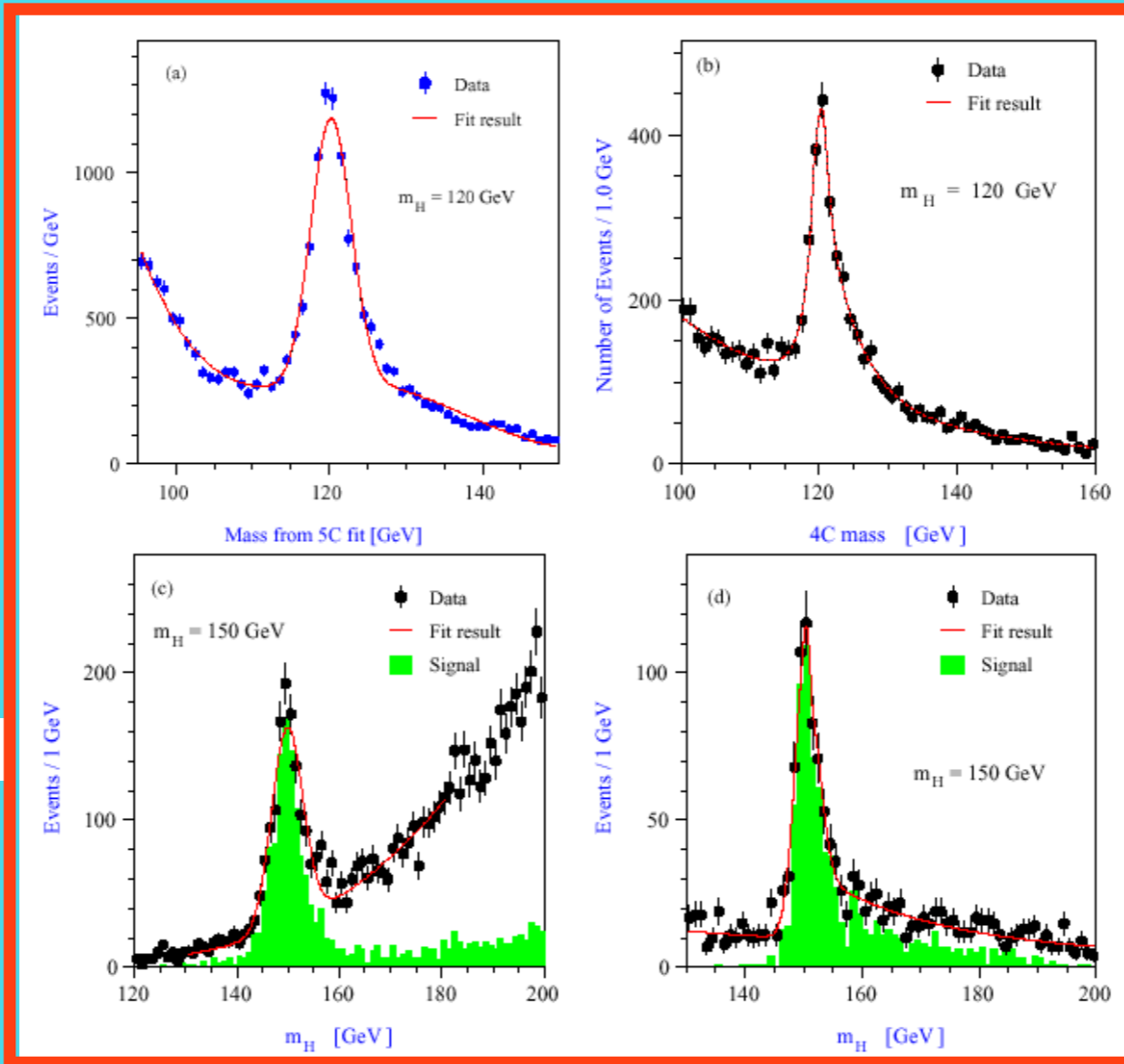

$\rightarrow q\bar{q}l^+l^-$

$\Delta m_H = 40 \text{ MeV}$

$\rightarrow W^+W^-l^+l^-$

$\Delta m_H = 70 \text{ MeV}$

Precision Physics of the Higgs bosons

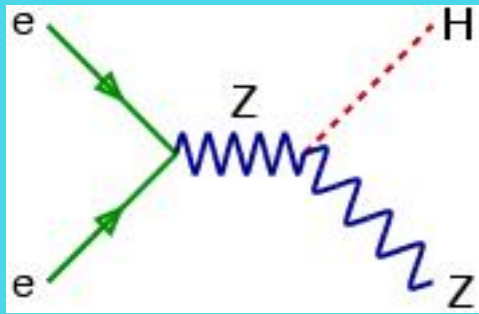

$$\rightarrow b\bar{b}q\bar{q}$$

$ee \rightarrow HZ$ diff. decay channels

Int Linear Collider

$$\rightarrow W^+W^-q\bar{q}$$

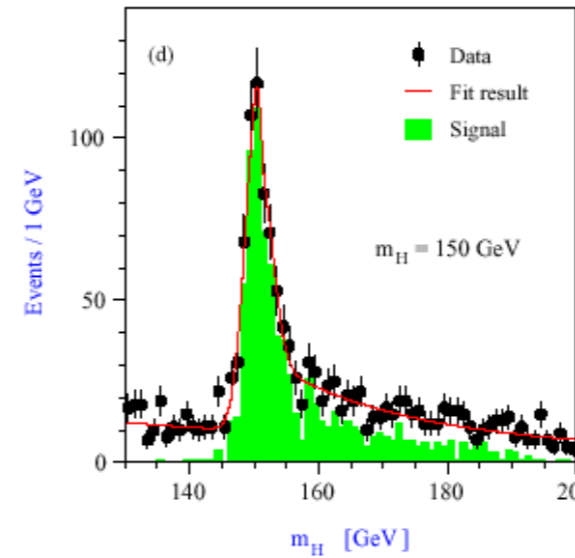
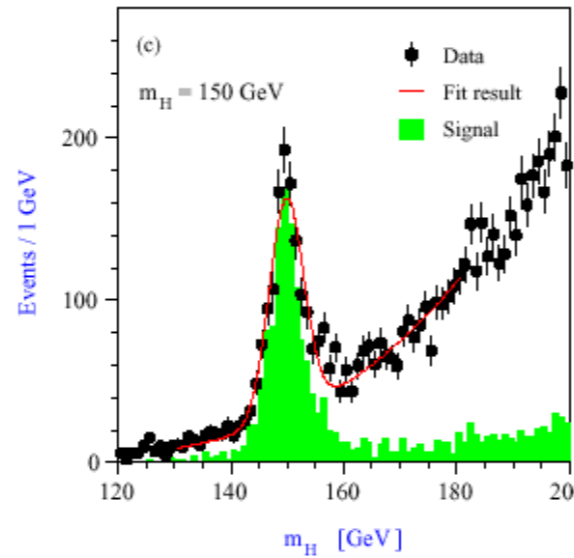
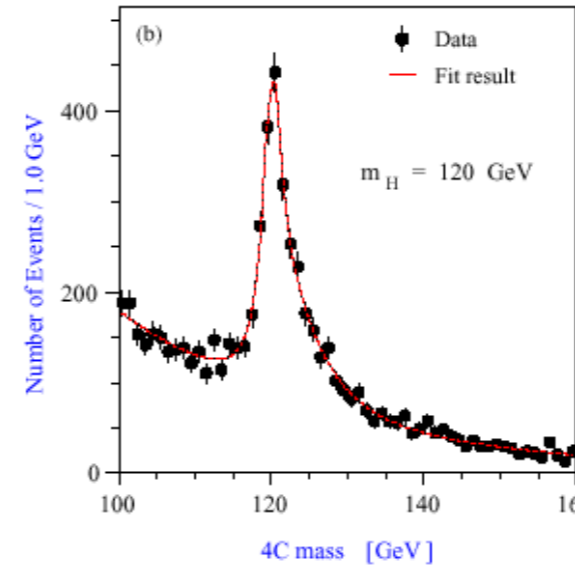
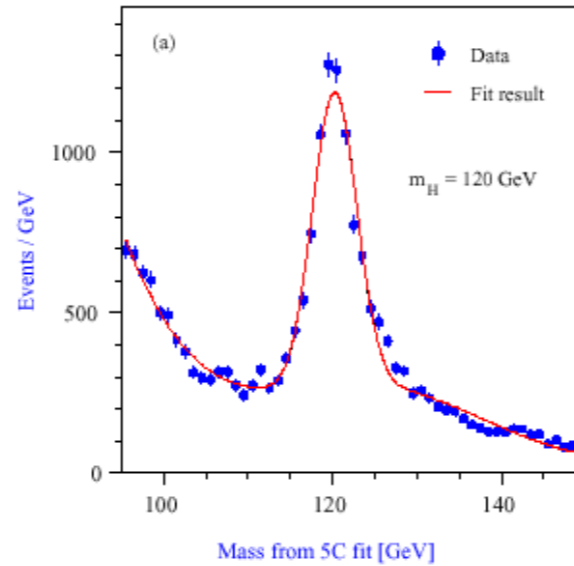

$$\rightarrow q\bar{q}l^+l^-$$

$\Delta m_H = 40 \text{ MeV}$

$$\rightarrow W^+W^-l^+l^-$$

$\Delta m_H = 70 \text{ MeV}$

Coupling Precision

LHC 300 fb⁻¹ x 2

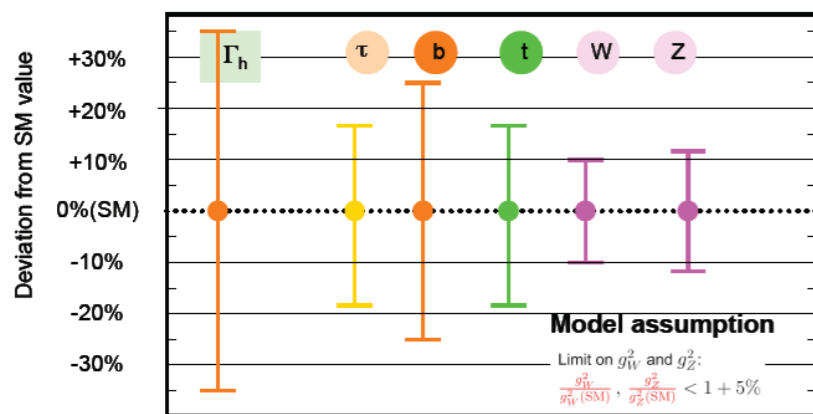

Coupling Precision

ILC

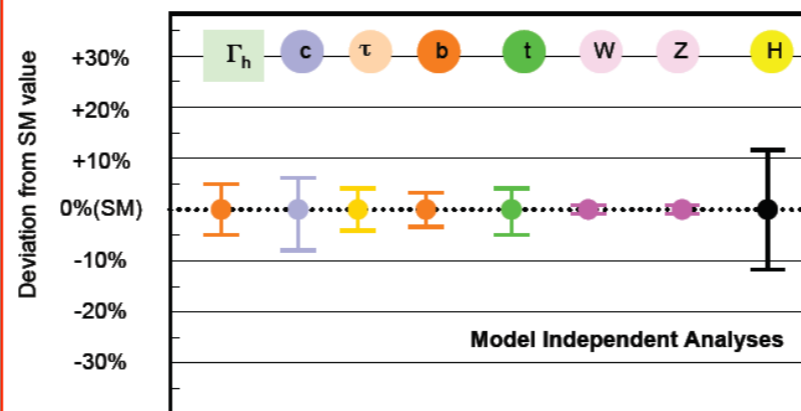

Precision Physics of the Higgs bosons

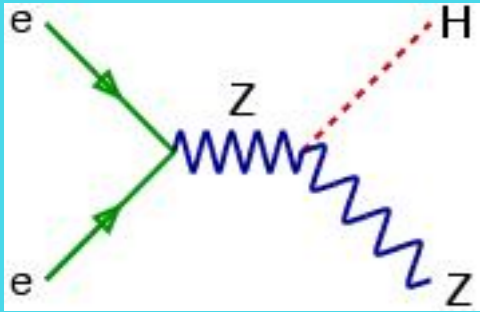

$$\rightarrow b\bar{b}q\bar{q}$$

$ee \rightarrow HZ$ diff. decay channels

Int Linear Collider

$$\rightarrow W^+W^-q\bar{q}$$

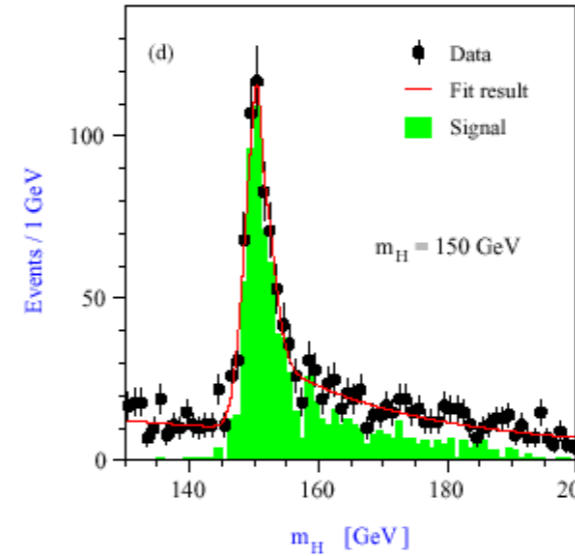
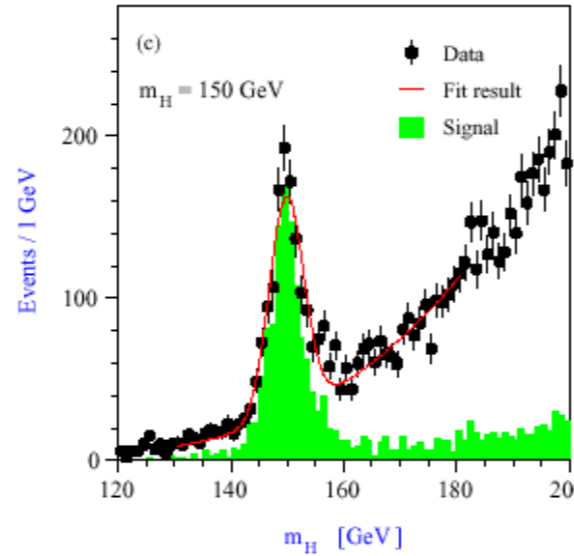
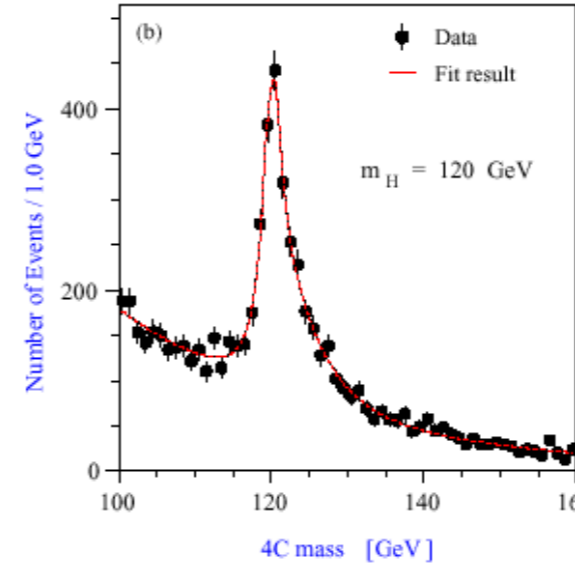
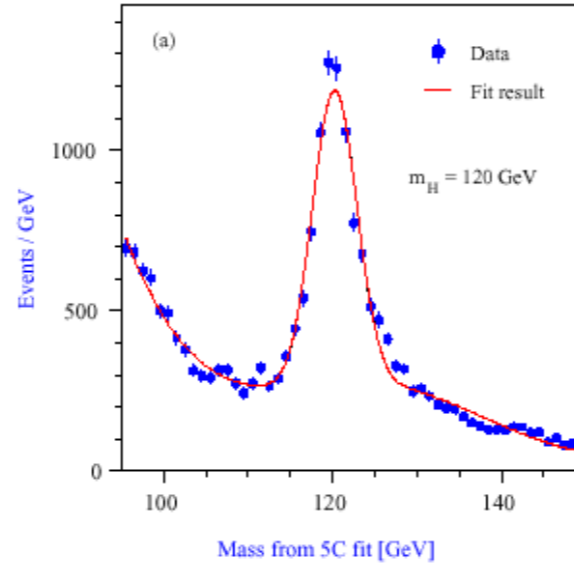

$$\rightarrow q\bar{q}l^+l^-$$

$$\Delta m_H = 40 \text{ MeV}$$

$$\rightarrow W^+W^-l^+l^-$$

$$\Delta m_H = 70 \text{ MeV}$$

Coupling Precision

LHC 300 fb⁻¹ x 2

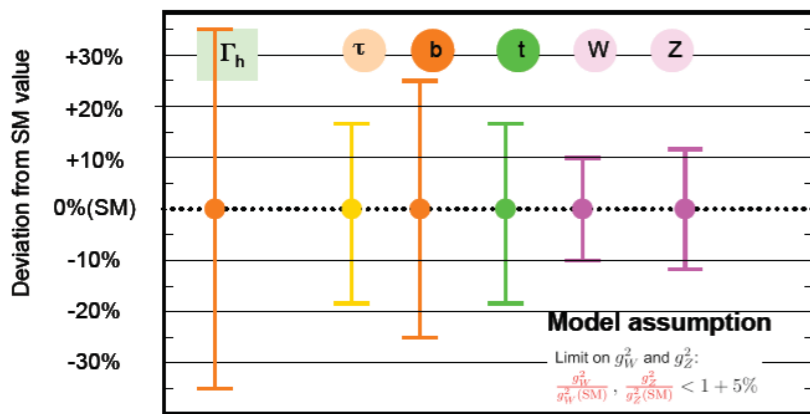

Coupling Precision

ILC

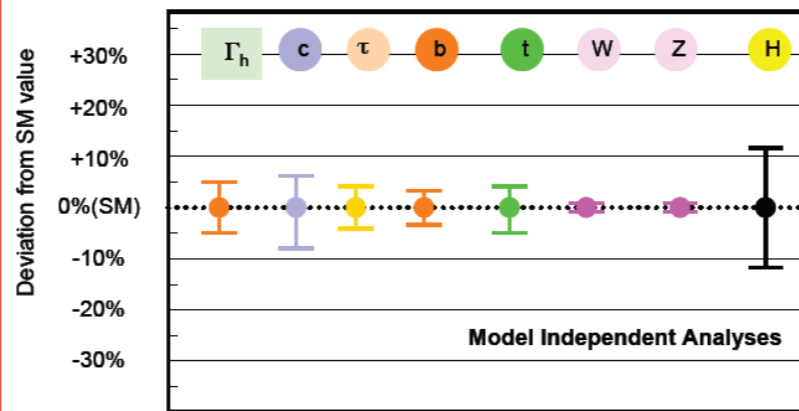

SUSY or 2HDM

ILC

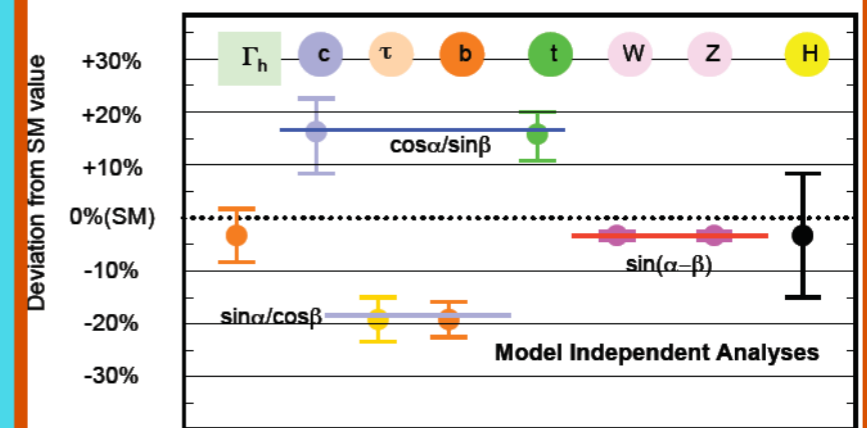

Neutrino Sector

Neutrino Sector

Neutrino masses

Neutrino Sector

Neutrino masses

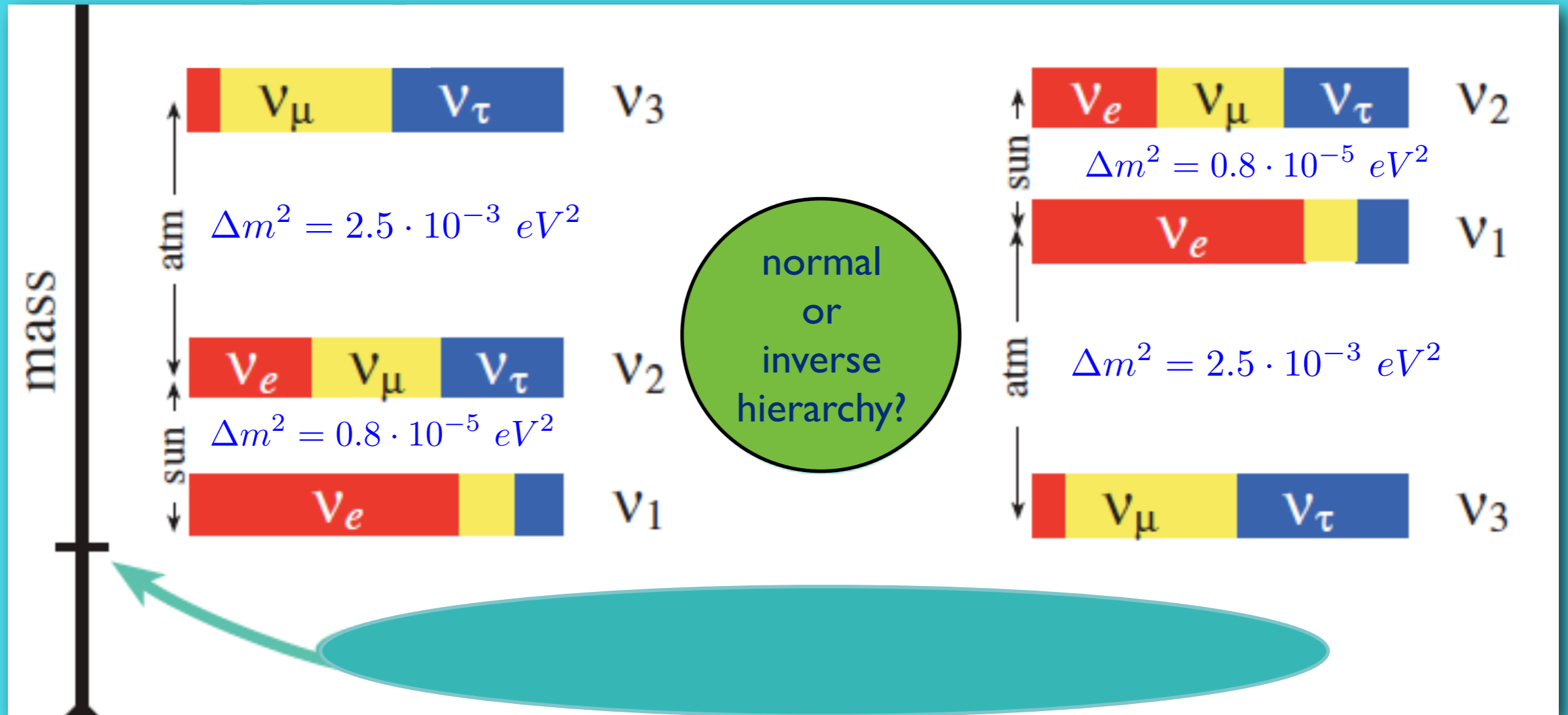

Neutrino Sector

Neutrino masses

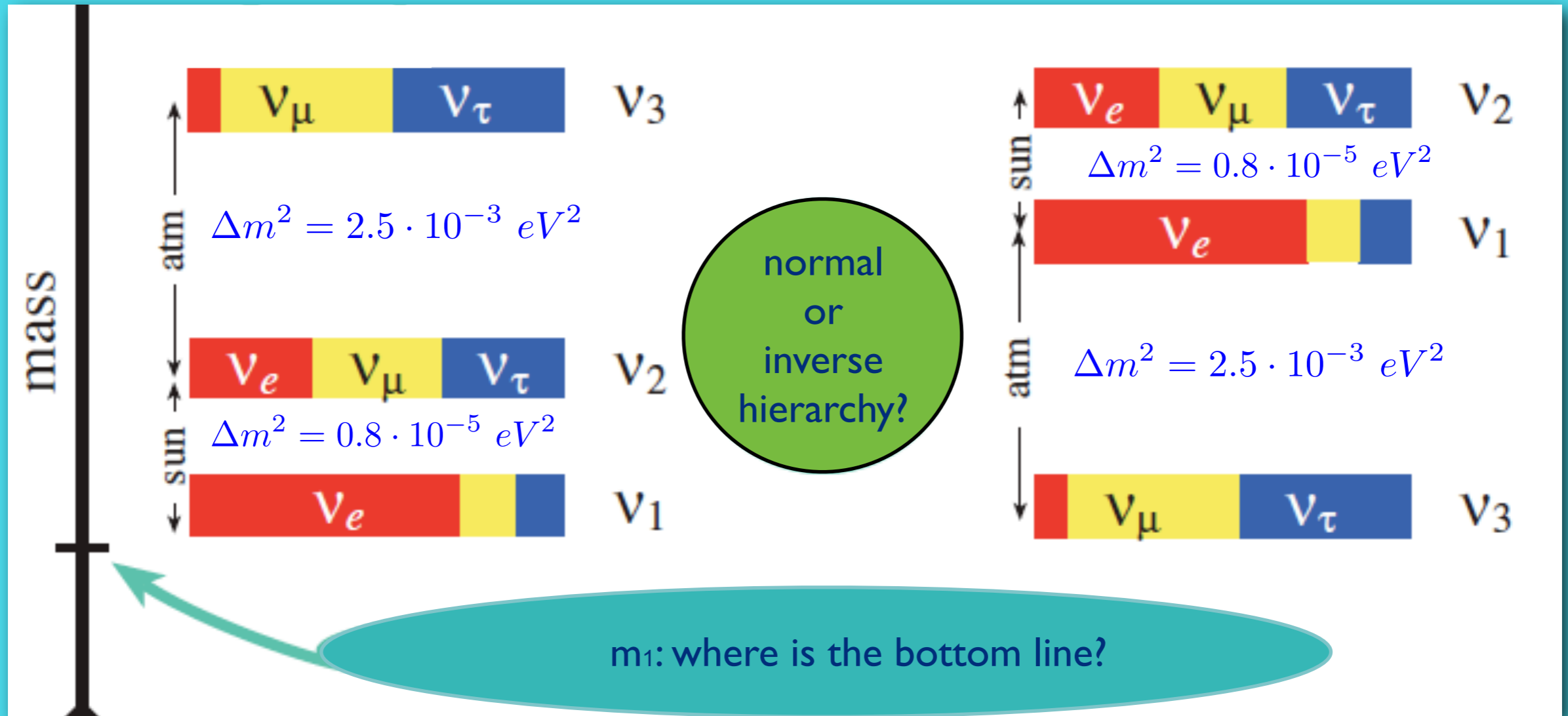

Neutrino Sector

Neutrino masses

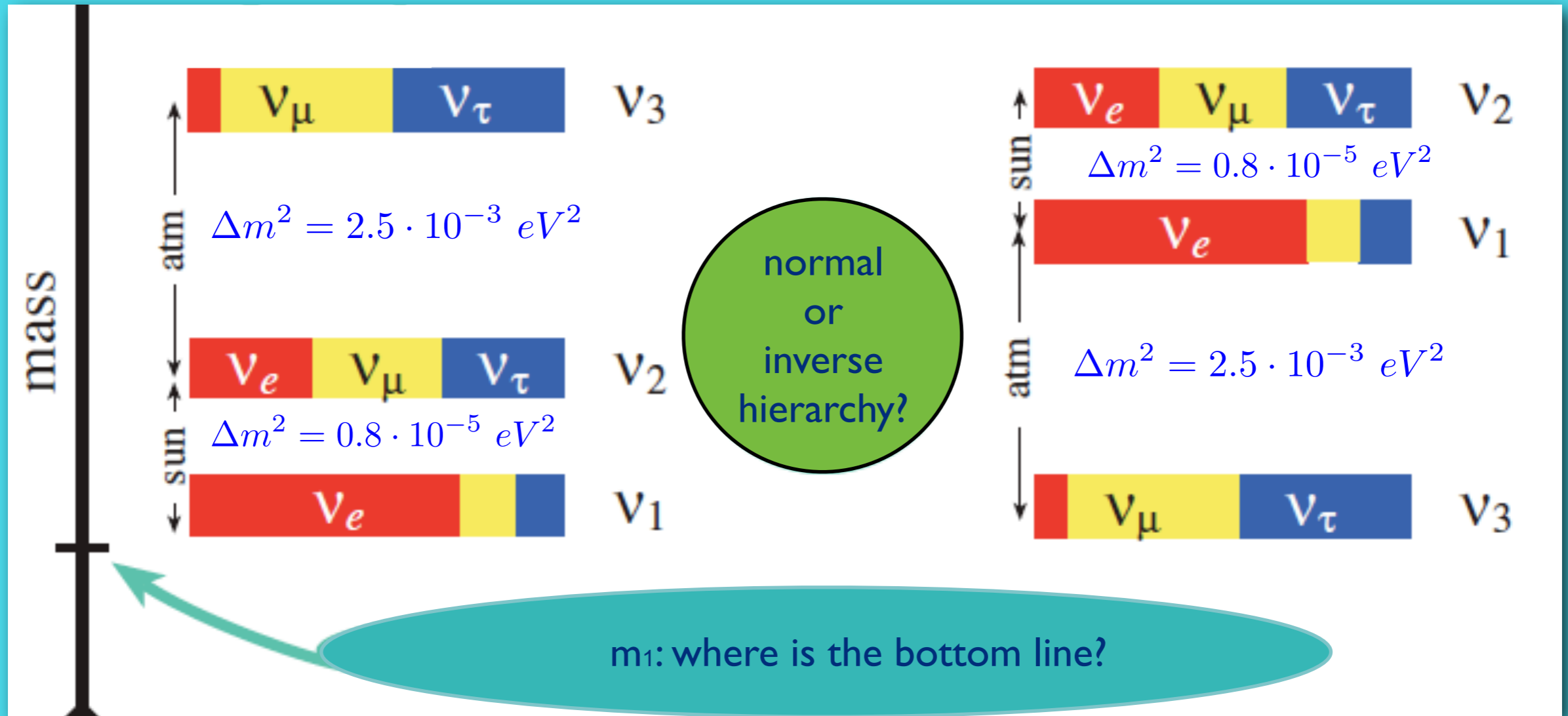

$$\sum m_\nu < 0.23 eV$$

cosmology: the CMB spectrum

Planck

Neutrino Sector

Neutrino masses

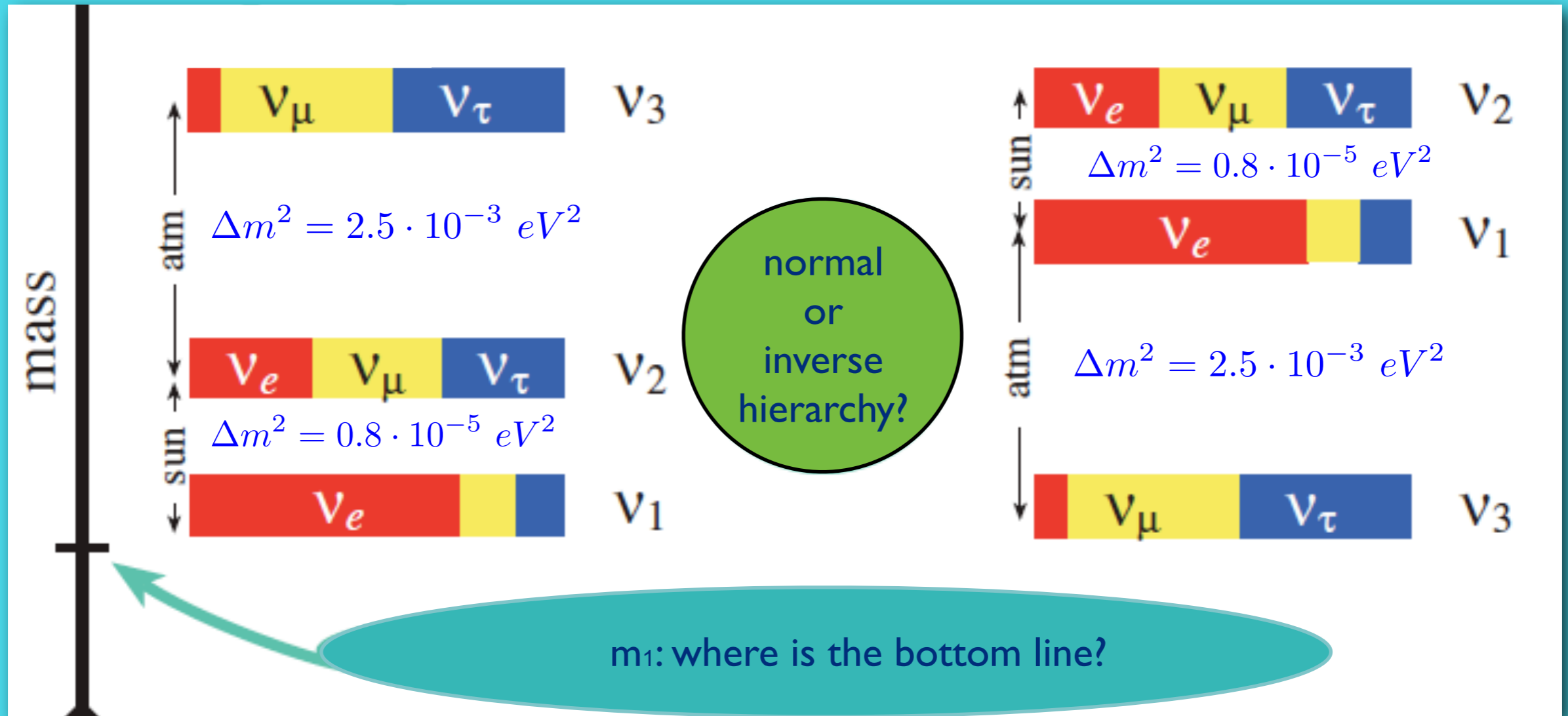

$$\sum m_\nu < 0.23 \text{ eV}$$

cosmology: the CMB spectrum

Planck

$$m_{\nu_e} < 2 \text{ eV}$$

β -decay
Troitsk-Mainz

Neutrino Sector

Neutrino masses

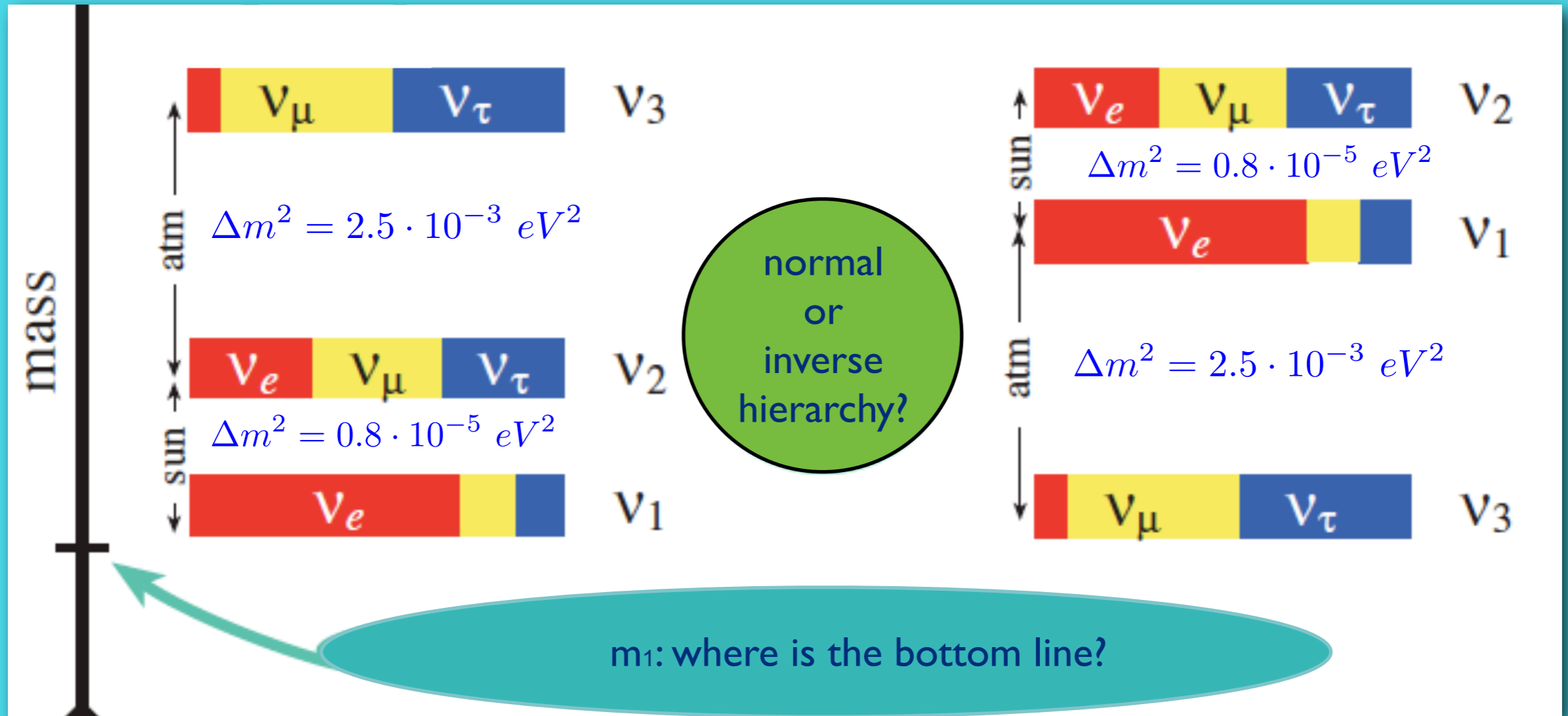

$$\sum m_\nu < 0.23 eV$$

cosmology: the CMB spectrum

Planck

$$m_{\nu_e} < 2 eV$$

β -decay
Troitsk-Mainz

$$m_{\nu_e} < 0.2 eV$$

KATRIN

Neutrino Sector

Dirac or Majorana?

$$\nu_D = \begin{pmatrix} \nu_L \\ \nu_R \end{pmatrix} \quad \nu_{M_1} = \begin{pmatrix} \xi_1 \\ \xi_1^* \end{pmatrix}, \quad \nu_{M_2} = \begin{pmatrix} \xi_2 \\ \xi_2^* \end{pmatrix}$$

Neutrino Sector

Dirac or Majorana?

$$\nu_D = \begin{pmatrix} \nu_L \\ \nu_R \end{pmatrix} \quad \nu_{M_1} = \begin{pmatrix} \xi_1 \\ \xi_1^* \end{pmatrix}, \quad \nu_{M_2} = \begin{pmatrix} \xi_2 \\ \xi_2^* \end{pmatrix}$$

$$\nu_D \neq \nu_D^*$$
$$m_{\nu_L} = m_{\nu_R}$$

Neutrino Sector

Dirac or Majorana?

$$\nu_D = \begin{pmatrix} \nu_L \\ \nu_R \end{pmatrix} \quad \nu_{M_1} = \begin{pmatrix} \xi_1 \\ \xi_1^* \end{pmatrix}, \quad \nu_{M_2} = \begin{pmatrix} \xi_2 \\ \xi_2^* \end{pmatrix}$$

$$\nu_D \neq \nu_D^* \\ m_{\nu_L} = m_{\nu_R}$$

$$\nu_M = \nu_M^* \\ m_{\nu_{M_1}} \neq m_{\nu_{M_2}}$$

Neutrino Sector

Dirac or Majorana?

$$\nu_D = \begin{pmatrix} \nu_L \\ \nu_R \end{pmatrix} \quad \nu_{M_1} = \begin{pmatrix} \xi_1 \\ \xi_1^* \end{pmatrix}, \quad \nu_{M_2} = \begin{pmatrix} \xi_2 \\ \xi_2^* \end{pmatrix}$$

$$\nu_D \neq \nu_D^* \\ m_{\nu_L} = m_{\nu_R}$$



$$\nu_M = \nu_M^* \\ m_{\nu_{M_1}} \neq m_{\nu_{M_2}}$$

Neutrino Sector

Dirac or Majorana?

$$\nu_D = \begin{pmatrix} \nu_L \\ \nu_R \end{pmatrix} \quad \nu_{M_1} = \begin{pmatrix} \xi_1 \\ \xi_1^* \end{pmatrix}, \quad \nu_{M_2} = \begin{pmatrix} \xi_2 \\ \xi_2^* \end{pmatrix}$$

$$\nu_D \neq \nu_D^* \\ m_{\nu_L} = m_{\nu_R}$$



$$\nu_M = \nu_M^* \\ m_{\nu_{M_1}} \neq m_{\nu_{M_2}}$$

$0\nu\beta\beta$ decay

Neutrino Sector

Dirac or Majorana?

$$\nu_D = \begin{pmatrix} \nu_L \\ \nu_R \end{pmatrix} \quad \nu_{M_1} = \begin{pmatrix} \xi_1 \\ \xi_1^* \end{pmatrix}, \quad \nu_{M_2} = \begin{pmatrix} \xi_2 \\ \xi_2^* \end{pmatrix}$$

$$\nu_D \neq \nu_D^* \\ m_{\nu_L} = m_{\nu_R}$$



$$\nu_M = \nu_M^* \\ m_{\nu_{M_1}} \neq m_{\nu_{M_2}}$$

$0\nu\beta\beta$ decay

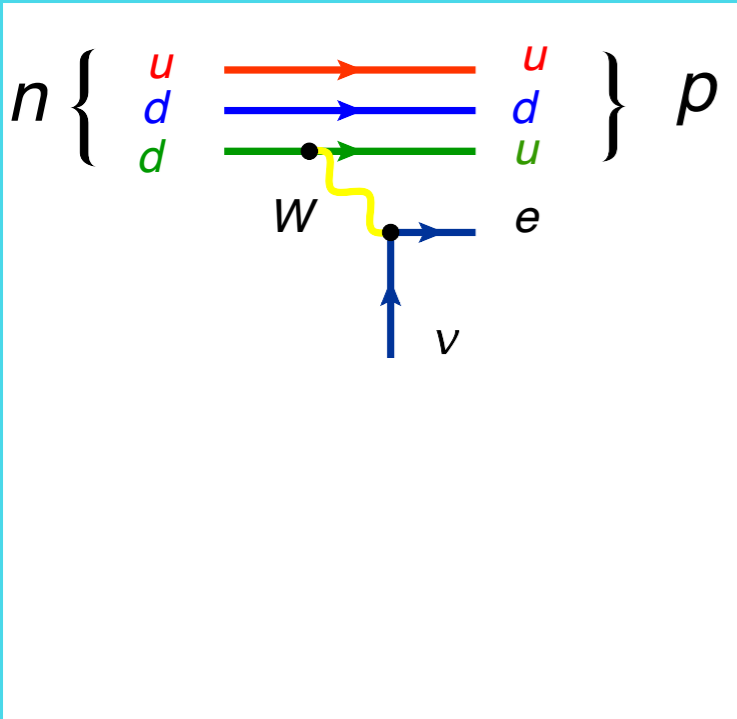

Neutrino Sector

Dirac or Majorana?

$$\nu_D = \begin{pmatrix} \nu_L \\ \nu_R \end{pmatrix} \quad \nu_{M_1} = \begin{pmatrix} \xi_1 \\ \xi_1^* \end{pmatrix}, \quad \nu_{M_2} = \begin{pmatrix} \xi_2 \\ \xi_2^* \end{pmatrix}$$

$$\nu_D \neq \nu_D^* \\ m_{\nu_L} = m_{\nu_R}$$



$$\nu_M = \nu_M^* \\ m_{\nu_{M_1}} \neq m_{\nu_{M_2}}$$

$0\nu\beta\beta$ decay

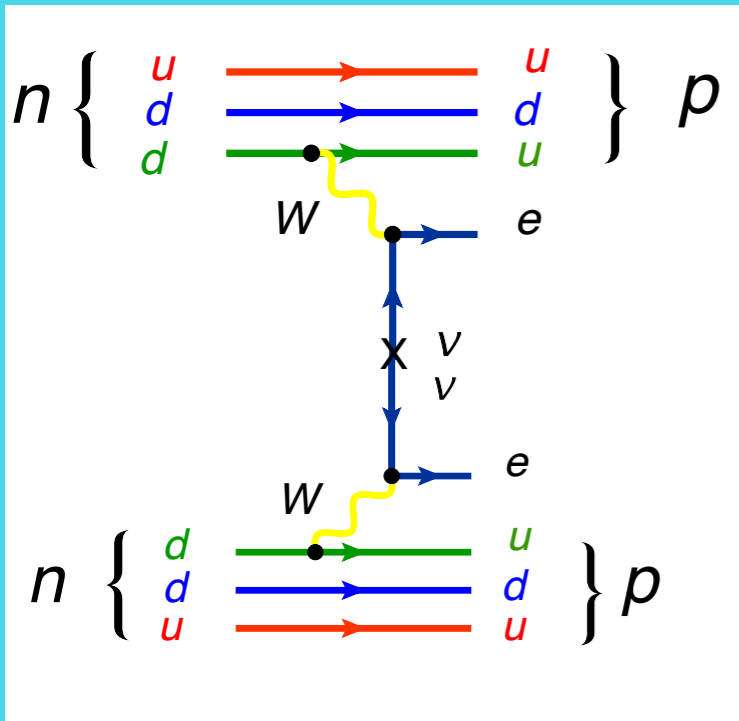

Neutrino Sector

Dirac or Majorana?

$$\nu_D = \begin{pmatrix} \nu_L \\ \nu_R \end{pmatrix} \quad \nu_{M_1} = \begin{pmatrix} \xi_1 \\ \xi_1^* \end{pmatrix}, \quad \nu_{M_2} = \begin{pmatrix} \xi_2 \\ \xi_2^* \end{pmatrix}$$

$$\nu_D \neq \nu_D^* \\ m_{\nu_L} = m_{\nu_R}$$



$$\nu_M = \nu_M^* \\ m_{\nu_{M_1}} \neq m_{\nu_{M_2}}$$

$0\nu\beta\beta$ decay

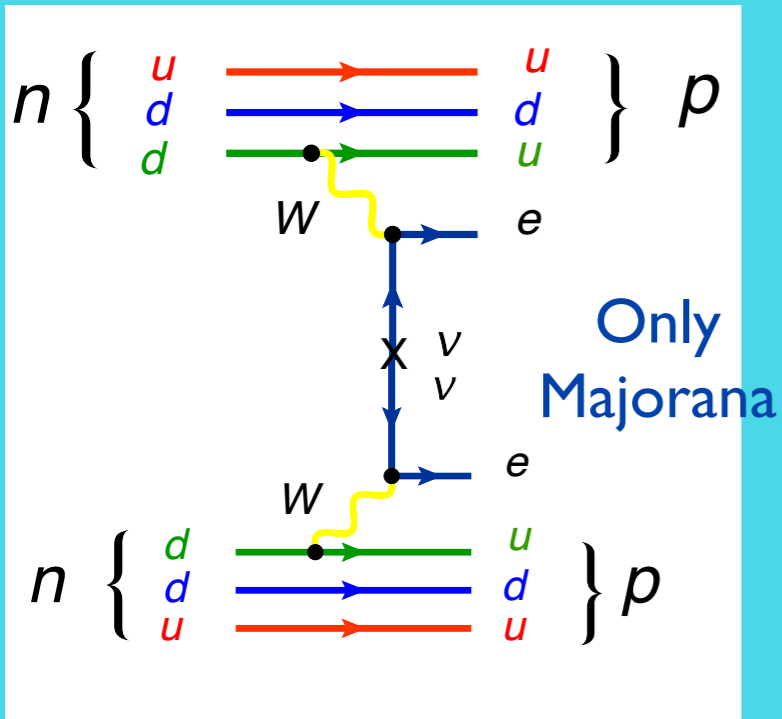

Neutrino Sector

Dirac or Majorana?

$$\nu_D = \begin{pmatrix} \nu_L \\ \nu_R \end{pmatrix} \quad \nu_{M_1} = \begin{pmatrix} \xi_1 \\ \xi_1^* \end{pmatrix}, \quad \nu_{M_2} = \begin{pmatrix} \xi_2 \\ \xi_2^* \end{pmatrix}$$

$$\nu_D \neq \nu_D^* \\ m_{\nu_L} = m_{\nu_R}$$



$$\nu_M = \nu_M^* \\ m_{\nu_{M_1}} \neq m_{\nu_{M_2}}$$

$0\nu\beta\beta$ decay

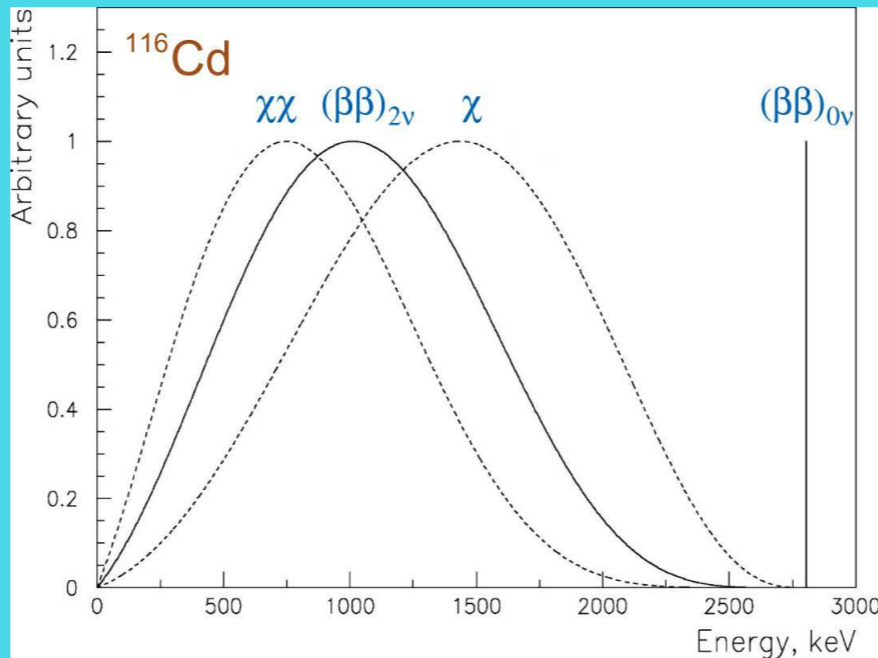
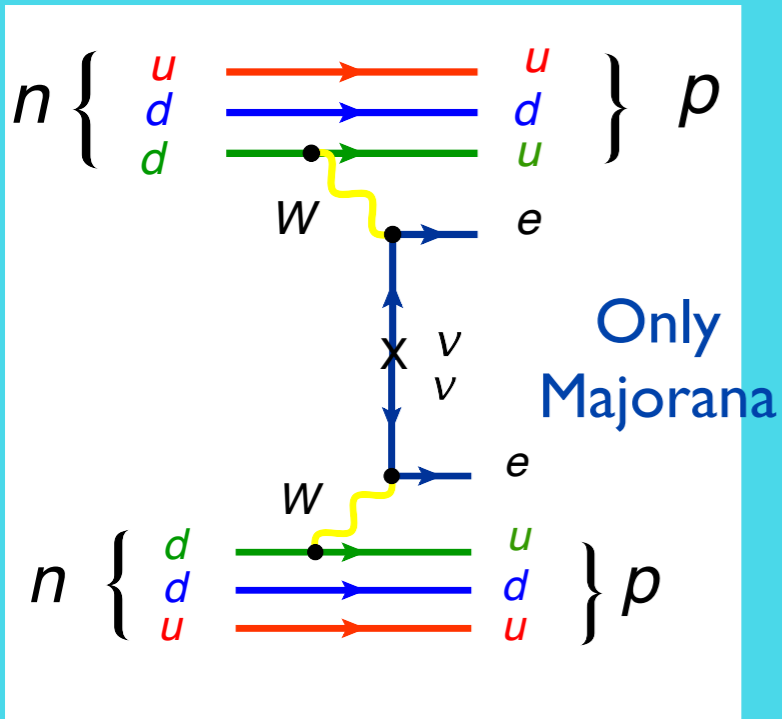

Neutrino Sector

Dirac or Majorana?

$$\nu_D = \begin{pmatrix} \nu_L \\ \nu_R \end{pmatrix} \quad \nu_{M_1} = \begin{pmatrix} \xi_1 \\ \xi_1^* \end{pmatrix}, \quad \nu_{M_2} = \begin{pmatrix} \xi_2 \\ \xi_2^* \end{pmatrix}$$

$$\nu_D \neq \nu_D^* \\ m_{\nu_L} = m_{\nu_R}$$



$$\nu_M = \nu_M^* \\ m_{\nu_{M_1}} \neq m_{\nu_{M_2}}$$

$0\nu\beta\beta$ decay

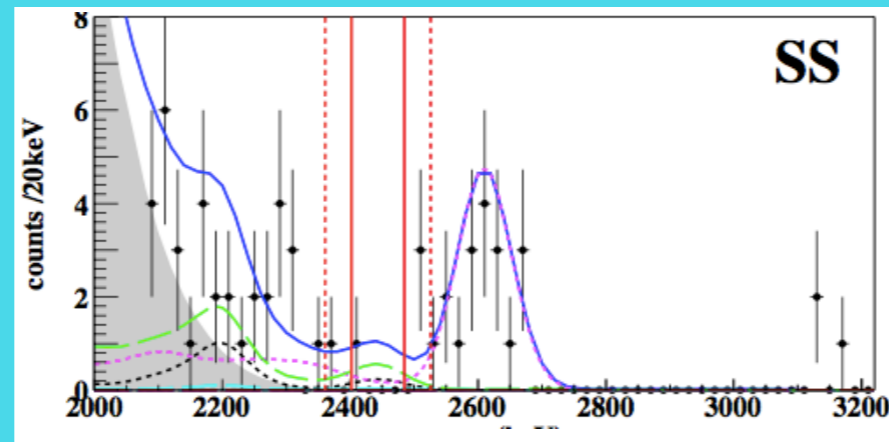
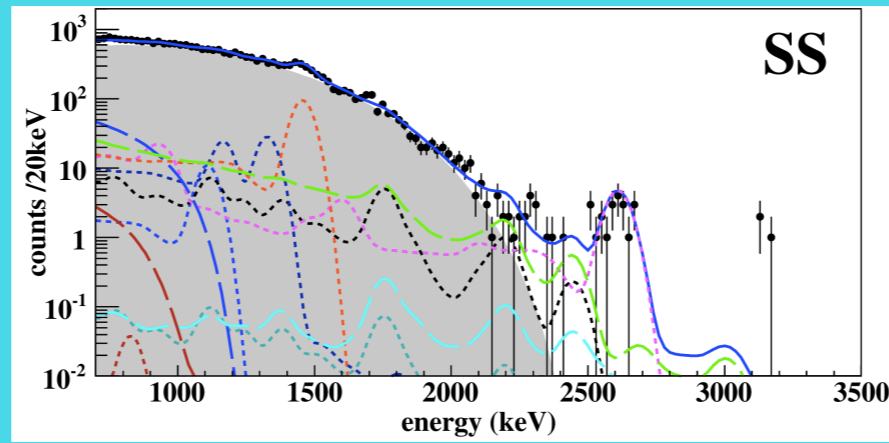
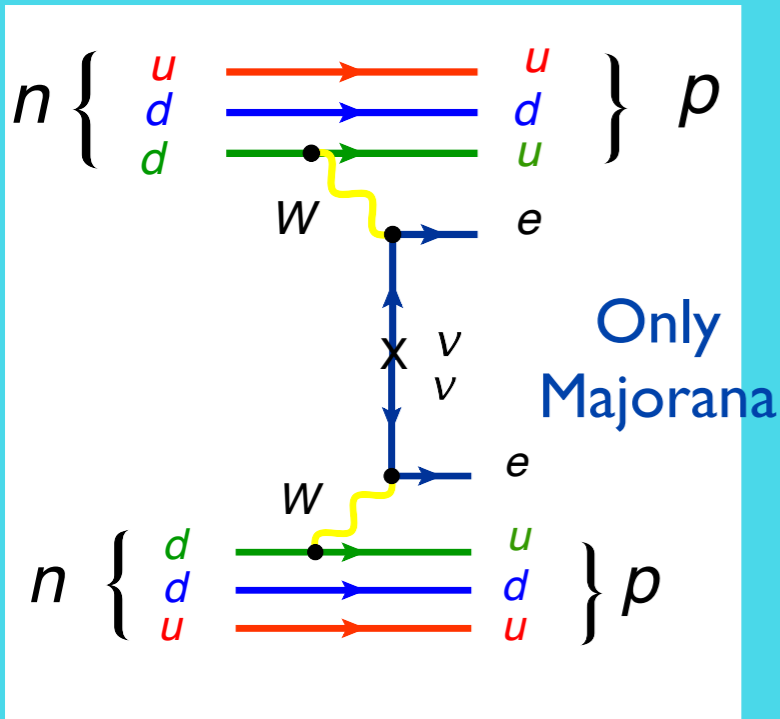

Candidate Isotope	Experiment
^{48}Ca	Candles
^{76}Ge	Gerda , Majorana
^{82}Se	SuperNemo, Lucifer
^{130}Te	CUORE
^{136}Xe	EXO , NEXT, KamLAND-Zen
^{150}Nd	SNO+

Neutrino Sector

Dirac or Majorana?

$$\nu_D = \begin{pmatrix} \nu_L \\ \nu_R \end{pmatrix} \quad \nu_{M_1} = \begin{pmatrix} \xi_1 \\ \xi_1^* \end{pmatrix}, \quad \nu_{M_2} = \begin{pmatrix} \xi_2 \\ \xi_2^* \end{pmatrix}$$

$$\nu_D \neq \nu_D^* \\ m_{\nu_L} = m_{\nu_R}$$



$$\nu_M = \nu_M^* \\ m_{\nu_{M_1}} \neq m_{\nu_{M_2}}$$

$0\nu\beta\beta$ decay

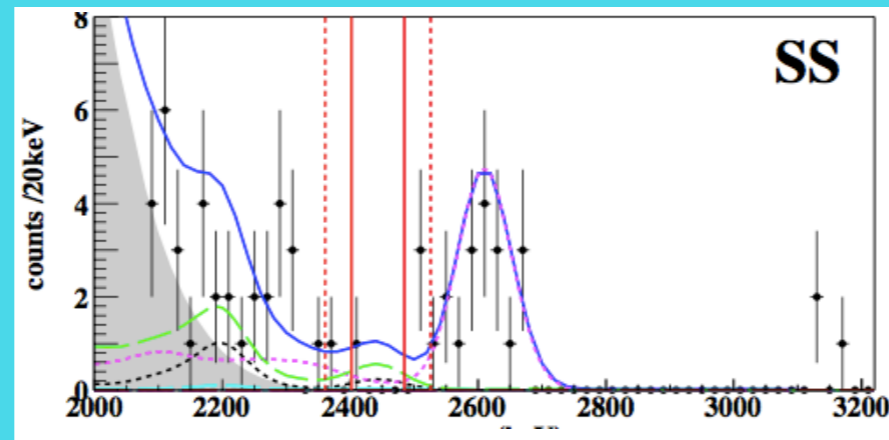
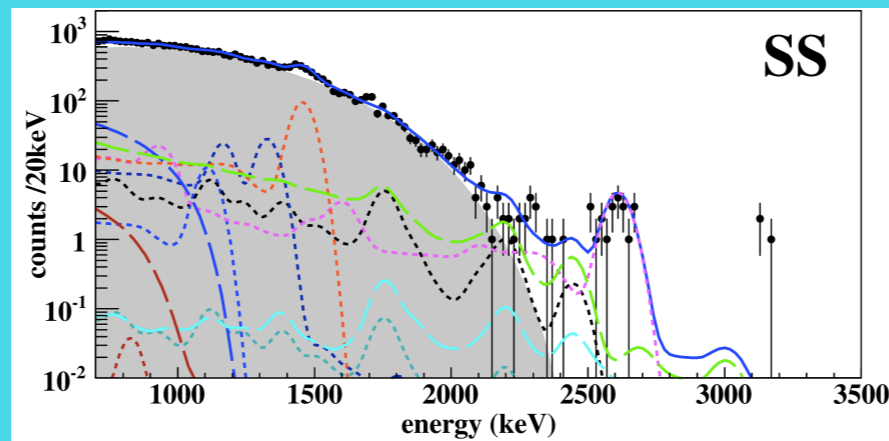
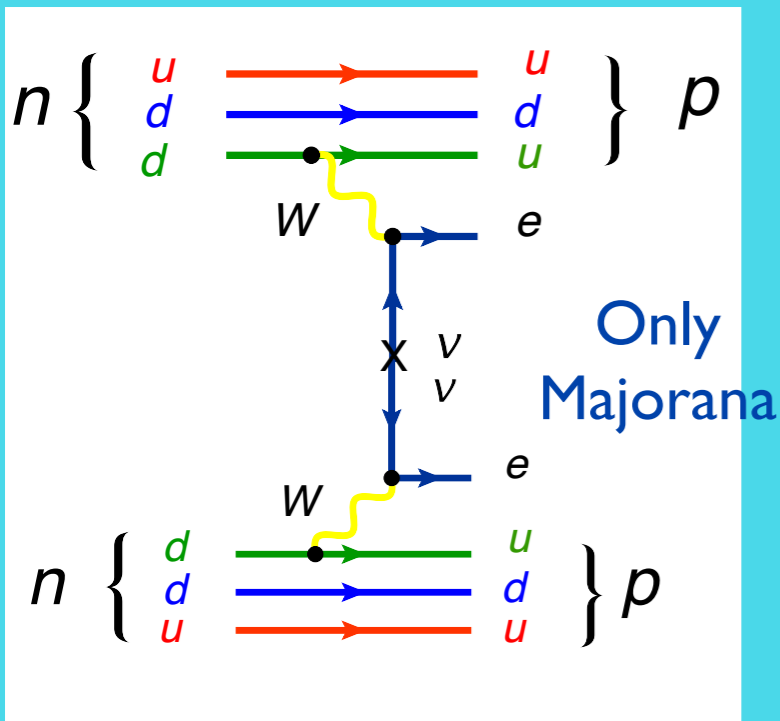

Candidate Isotope	Experiment
⁴⁸ Ca	Candles
⁷⁶ Ge	Gerda , Majorana
⁸² Se	SuperNemo, Lucifer
¹³⁰ Te	CUORE
¹³⁶ Xe	EXO , NEXT, KamLAND-Zen
¹⁵⁰ Nd	SNO+

$$T_{1/2} 2\nu\beta\beta (^{136}\text{Xe}) \times 10^{21} \text{ yr} = 2.23 \pm 0.017 \text{ stat} \pm 0.22 \text{ sys}$$

Neutrino Sector

Dirac or Majorana?

$$\nu_D = \begin{pmatrix} \nu_L \\ \nu_R \end{pmatrix} \quad \nu_{M_1} = \begin{pmatrix} \xi_1 \\ \xi_1^* \end{pmatrix}, \quad \nu_{M_2} = \begin{pmatrix} \xi_2 \\ \xi_2^* \end{pmatrix}$$

$$\nu_D \neq \nu_D^* \\ m_{\nu_L} = m_{\nu_R}$$



$$\nu_M = \nu_M^* \\ m_{\nu_{M_1}} \neq m_{\nu_{M_2}}$$

$0\nu\beta\beta$ decay

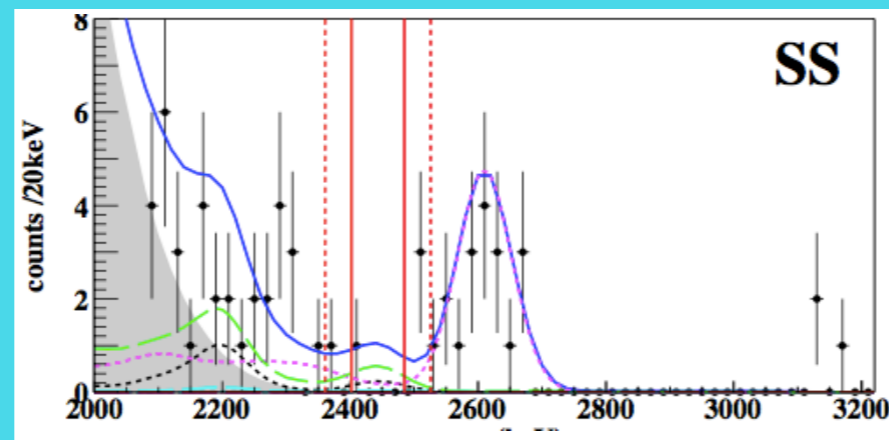
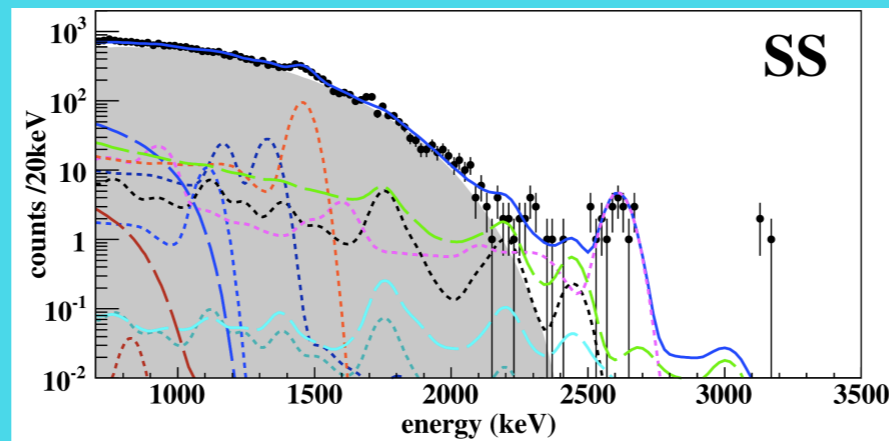
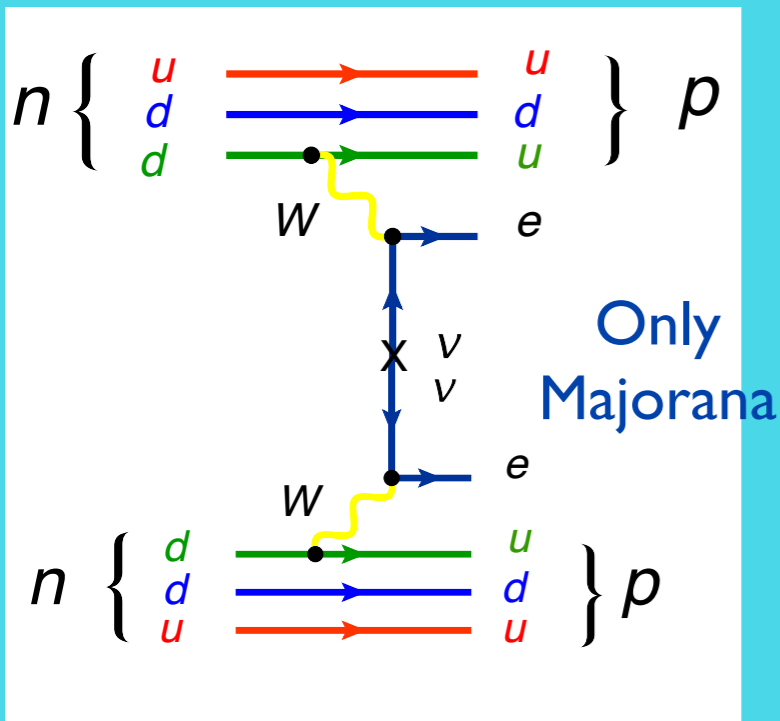

Candidate Isotope	Experiment
⁴⁸ Ca	Candles
⁷⁶ Ge	Gerda , Majorana
⁸² Se	SuperNemo, Lucifer
¹³⁰ Te	CUORE
¹³⁶ Xe	EXO , NEXT, KamLAND-Zen
¹⁵⁰ Nd	SNO+

$$T_{1/2} 2\nu\beta\beta (^{136}\text{Xe}) \times 10^{21} \text{ yr} = 2.23 \pm 0.017 \text{ stat} \pm 0.22 \text{ sys}$$

$$T_{1/2} 0\nu\beta\beta (^{136}\text{Xe}) \times 10^{25} \text{ yr} > 1.6 \text{ (90\% CL)}$$

Flavour Sector

Flavour Sector

- Number of Generations?

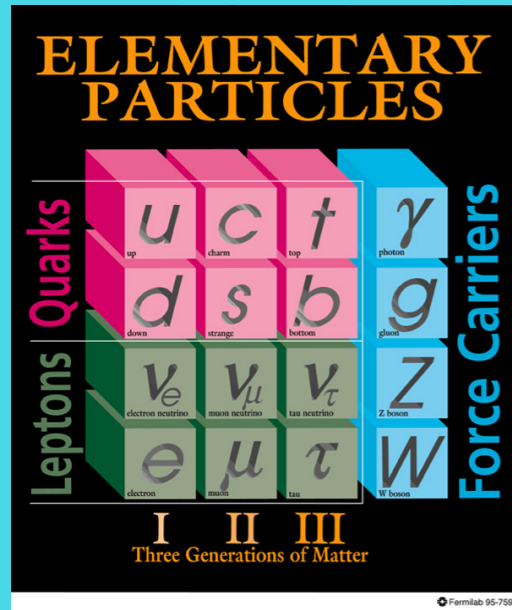

Flavour Sector

- Number of Generations?

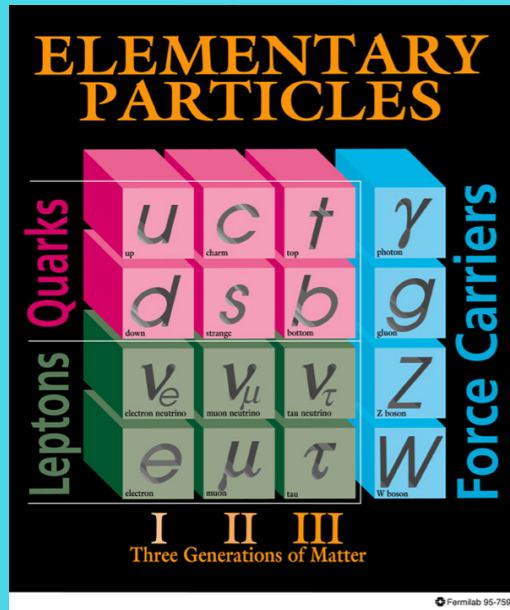

- The width of the Z-boson (LEP)

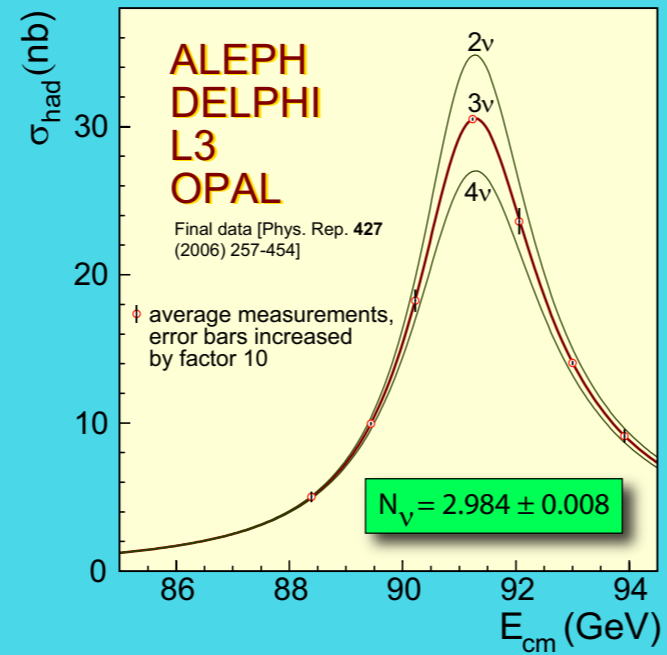

Flavour Sector

- Number of Generations?

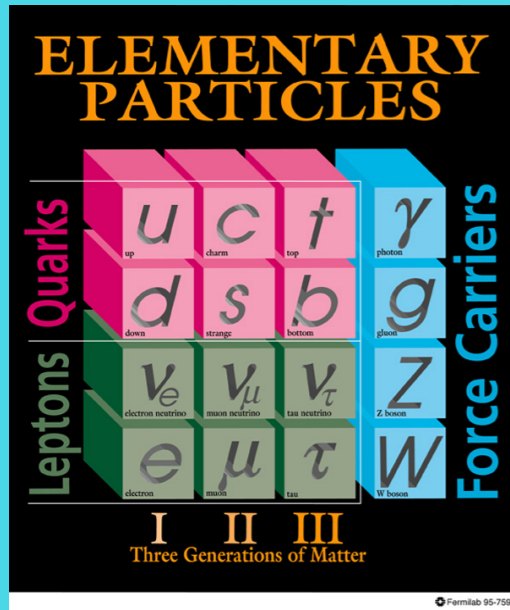

- The width of the Z-boson (LEP)

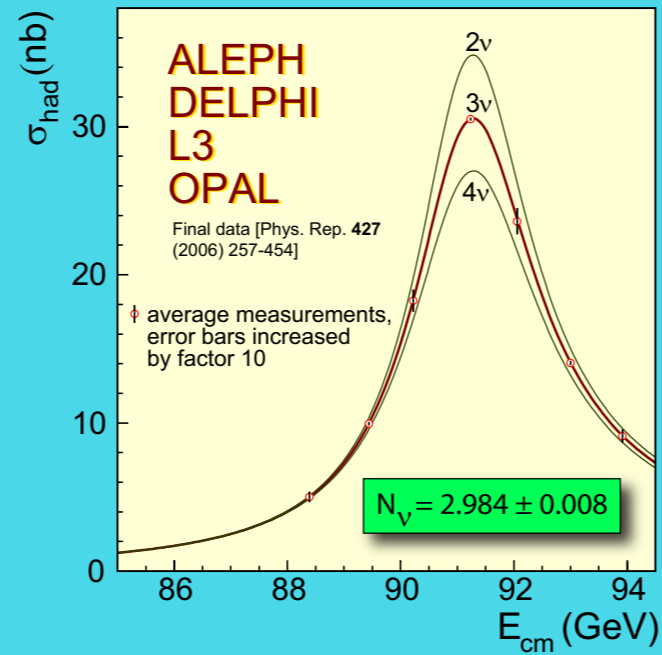

- The CMB spectrum (Planck)

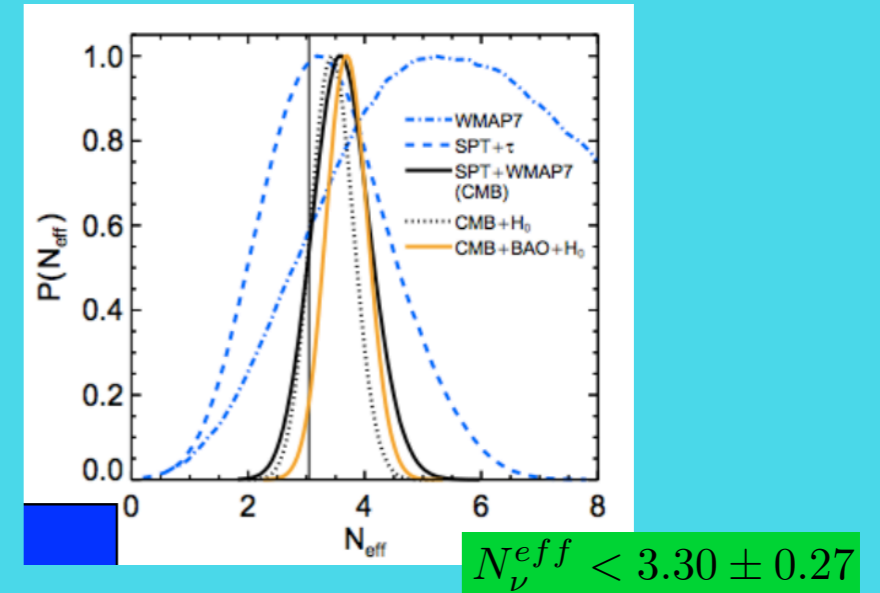

Flavour Sector

- Number of Generations?

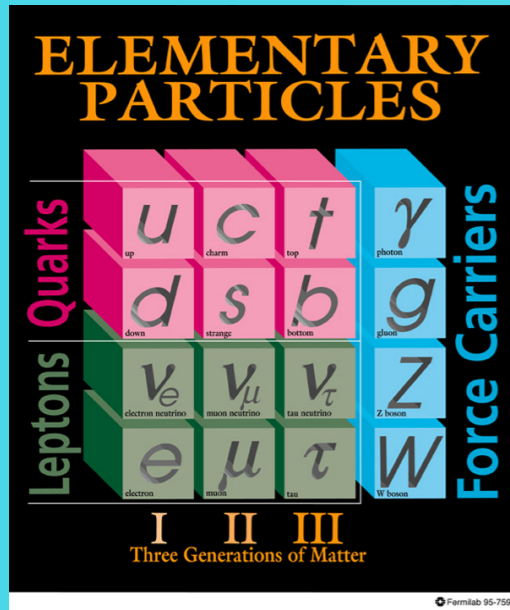

- The width of the Z-boson (LEP)

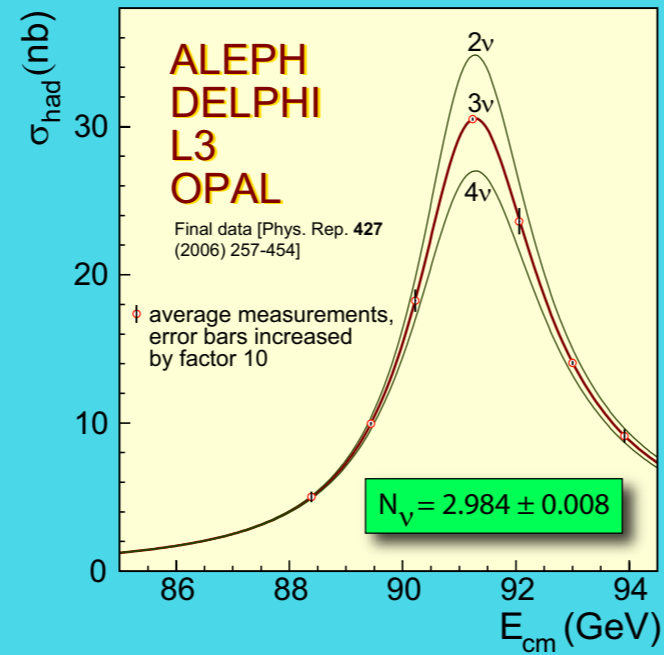

- Why 3 copies?

- The CMB spectrum (Planck)

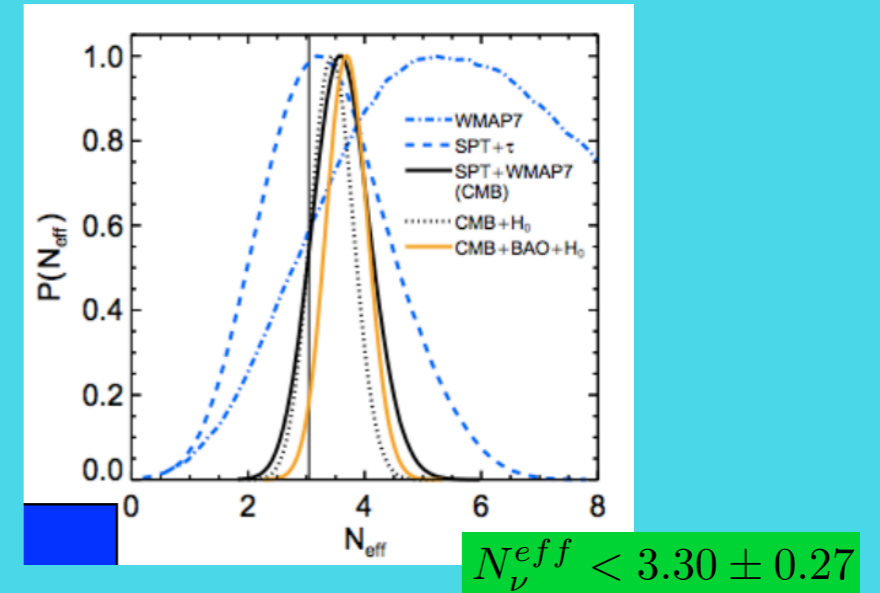

Flavour Sector

- Number of Generations?

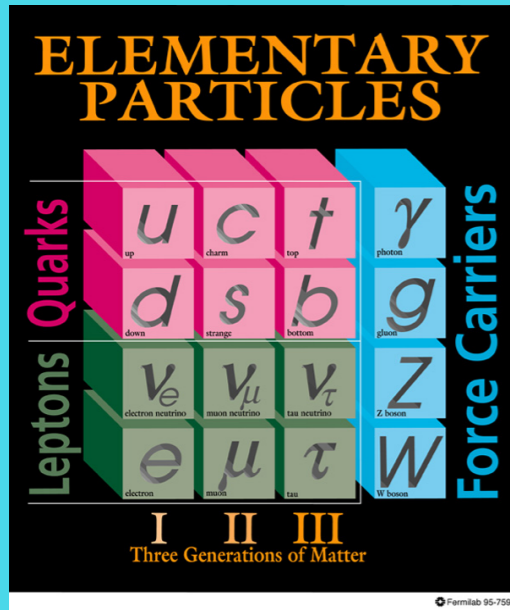

- The width of the Z-boson (LEP)

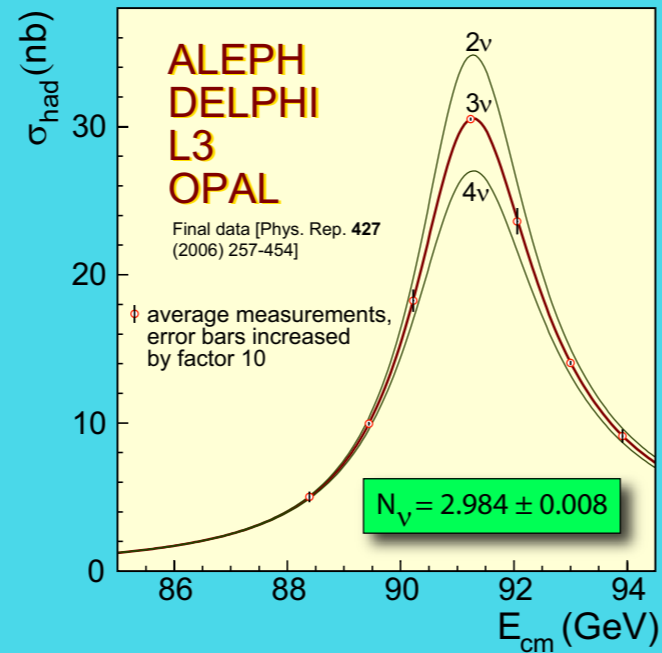

- The CMB spectrum (Planck)

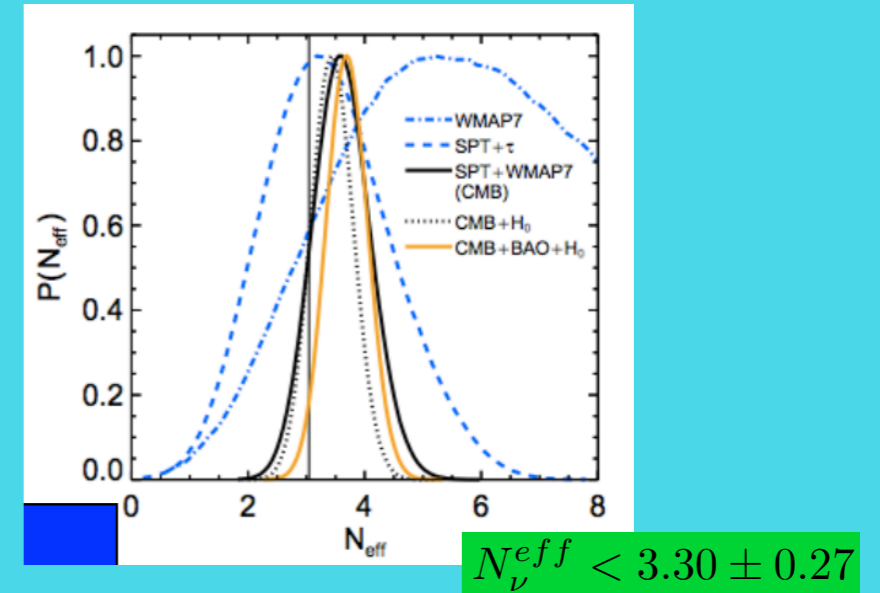

- Why 3 copies?
- The necessary condition for the baryon asymmetry of the Universe - CP violation

Flavour Sector

- Number of Generations?

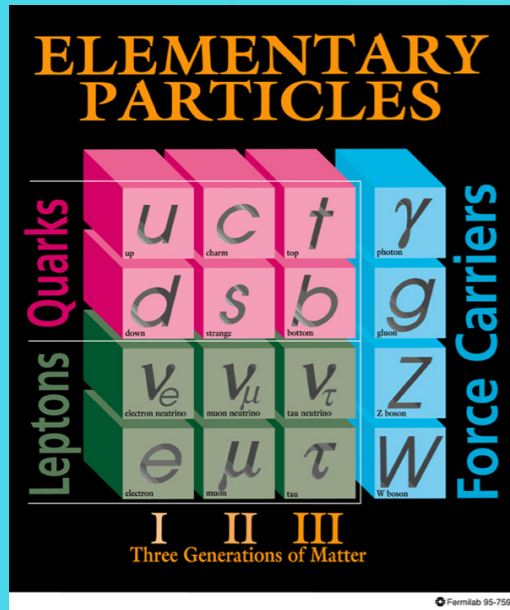

- The width of the Z-boson (LEP)

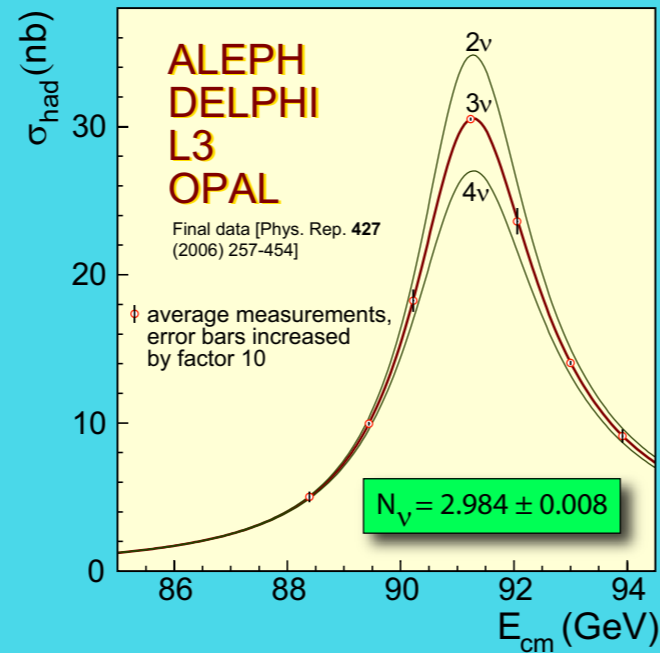

- The CMB spectrum (Planck)

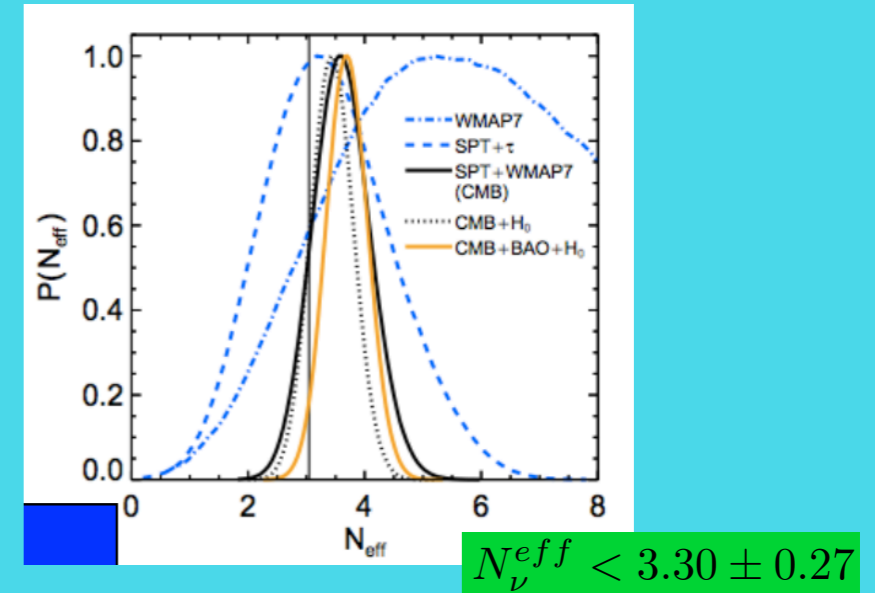

- Why 3 copies?
- The necessary condition for the baryon asymmetry of the Universe - CP violation
- CP in the SM comes from the non-zero phase in the quark (and lepton) mixing matrices

Flavour Sector

- Number of Generations?

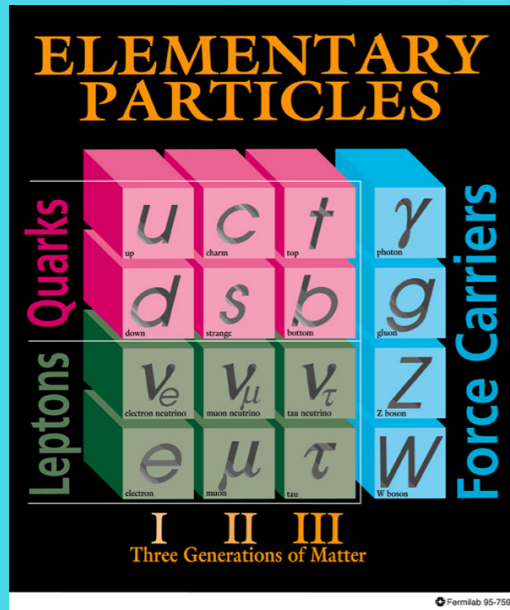

- The width of the Z-boson (LEP)

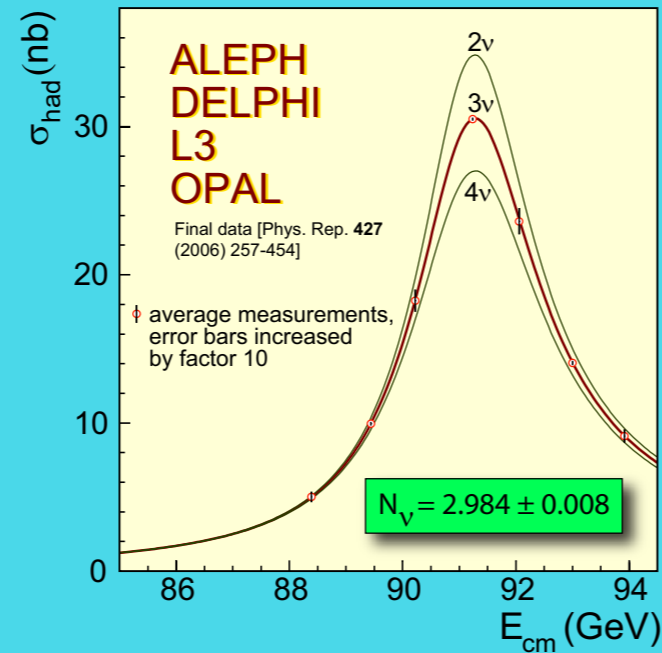

- The CMB spectrum (Planck)

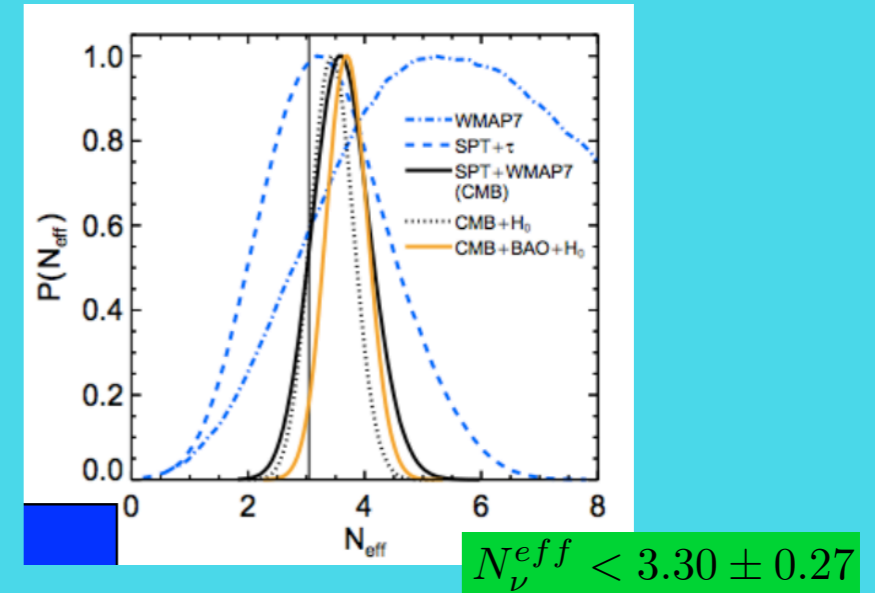

- Why 3 copies?
- The necessary condition for the baryon asymmetry of the Universe - CP violation
- CP in the SM comes from the non-zero phase in the quark (and lepton) mixing matrices
- Non-zero phase appears only if the number of generations $N \geq 3$

Flavour Sector

- Number of Generations?

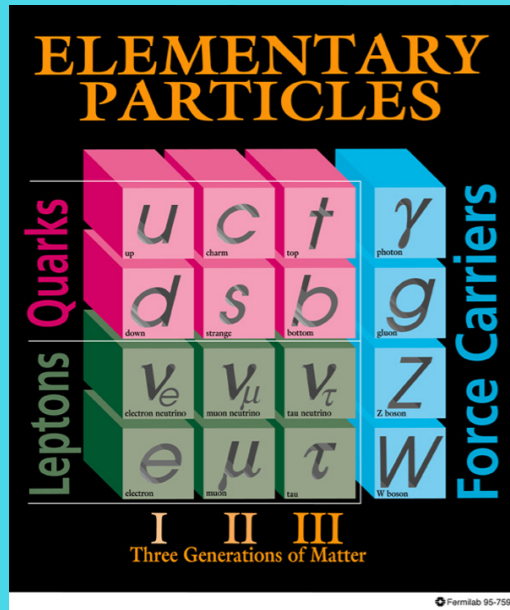

- The width of the Z-boson (LEP)

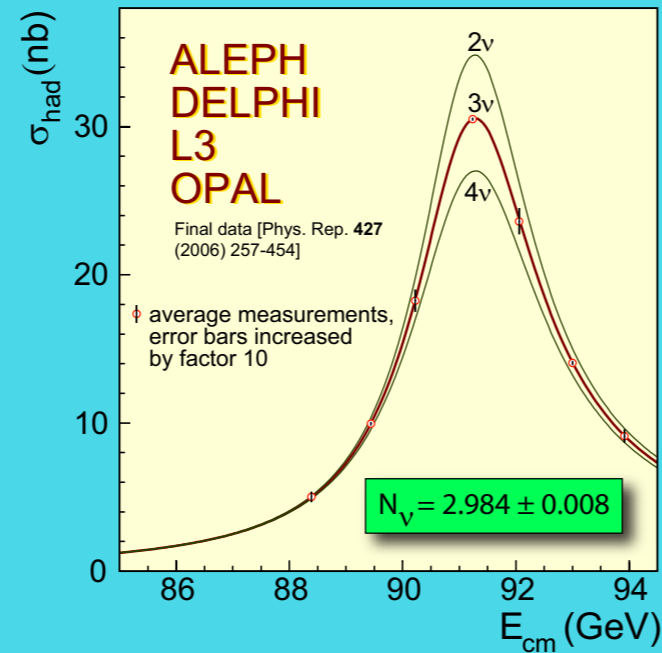

- The CMB spectrum (Planck)

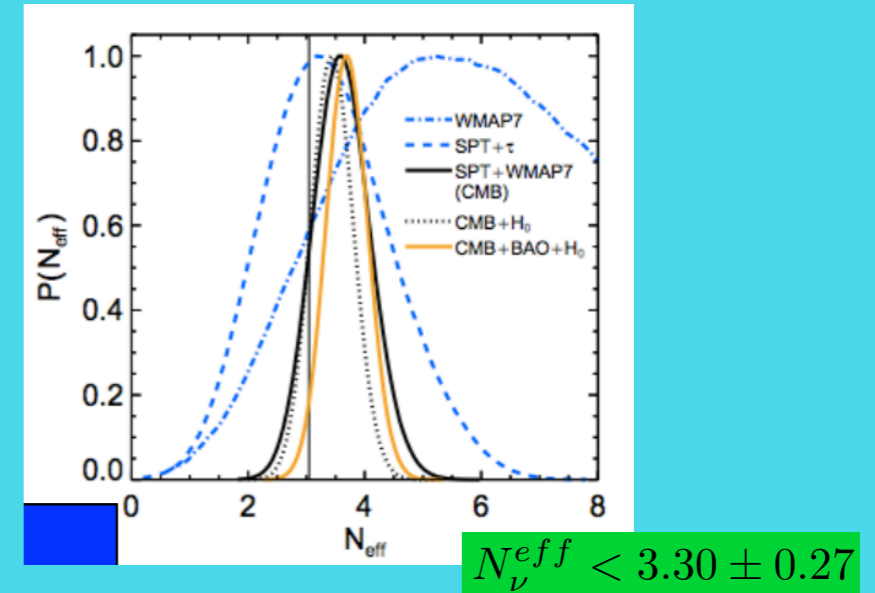

- Why 3 copies?

- The necessary condition for the baryon asymmetry of the Universe - CP violation
- CP in the SM comes from the non-zero phase in the quark (and lepton) mixing matrices
- Non-zero phase appears only if the number of generations $N \geq 3$

$$K = \begin{pmatrix} V_{ud} & V_{us} & V_{ub} \\ V_{cd} & V_{cs} & V_{cb} \\ V_{td} & V_{ts} & V_{tb} \end{pmatrix} = \begin{pmatrix} c_{12}c_{13} & s_{12}c_{13} & s_{13}e^{-i\delta} \\ -s_{12}c_{23} - c_{12}s_{23}s_{13}e^{i\delta} & c_{12}c_{23} - s_{12}s_{23}s_{13}e^{i\delta} & s_{23}c_{13} \\ s_{12}s_{23} - c_{12}c_{23}s_{13}e^{i\delta} & -c_{12}s_{23} - s_{12}c_{23}s_{13}e^{i\delta} & c_{23}c_{13} \end{pmatrix}$$

Flavour Sector

- Number of Generations?

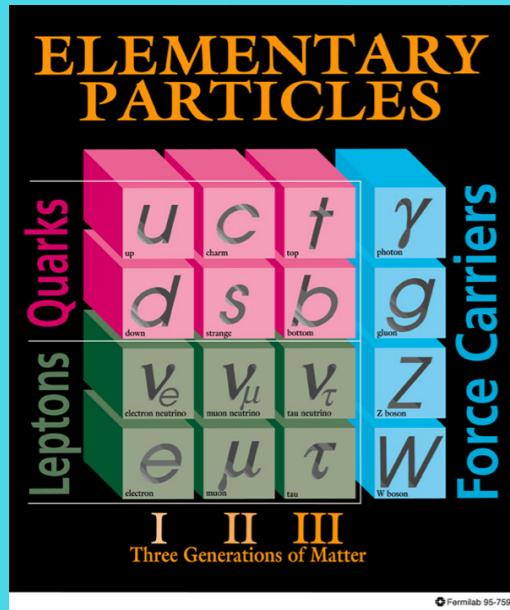

- The width of the Z-boson (LEP)

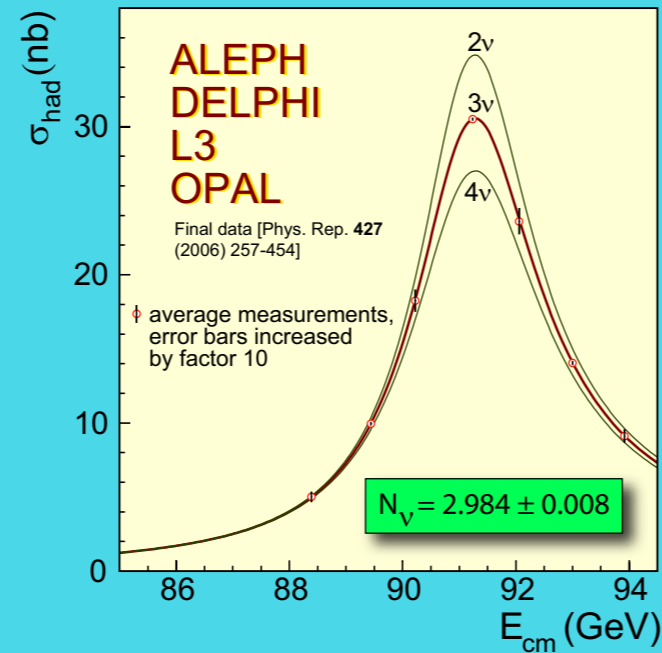

- The CMB spectrum (Planck)

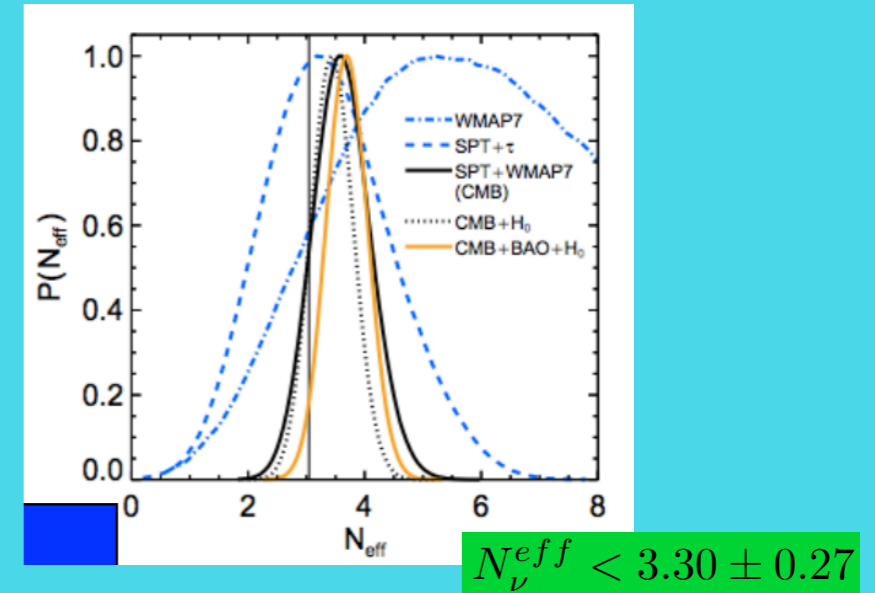

- Why 3 copies?

- The necessary condition for the baryon asymmetry of the Universe - CP violation
- CP in the SM comes from the non-zero phase in the quark (and lepton) mixing matrices
- Non-zero phase appears only if the number of generations $N \geq 3$

$$K = \begin{pmatrix} V_{ud} & V_{us} & V_{ub} \\ V_{cd} & V_{cs} & V_{cb} \\ V_{td} & V_{ts} & V_{tb} \end{pmatrix} = \begin{pmatrix} c_{12}c_{13} & s_{12}c_{13} & s_{13}e^{-i\delta} \\ -s_{12}c_{23} - c_{12}s_{23}s_{13}e^{i\delta} & c_{12}c_{23} - s_{12}s_{23}s_{13}e^{i\delta} & s_{23}c_{13} \\ s_{12}s_{23} - c_{12}c_{23}s_{13}e^{i\delta} & -c_{12}s_{23} - s_{12}c_{23}s_{13}e^{i\delta} & c_{23}c_{13} \end{pmatrix}$$

Flavour Sector

- Number of Generations?

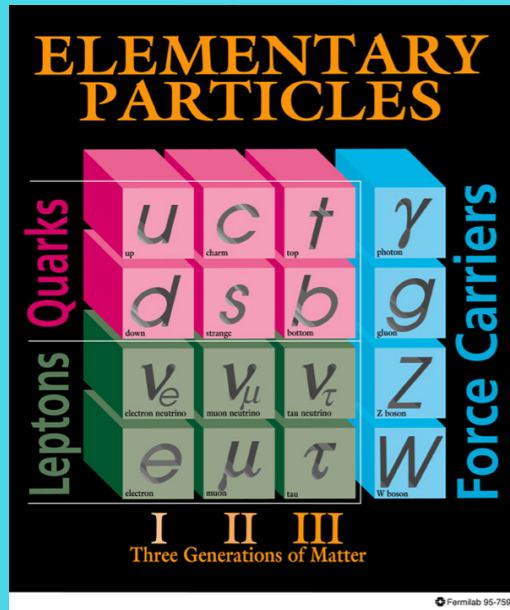

- The width of the Z-boson (LEP)

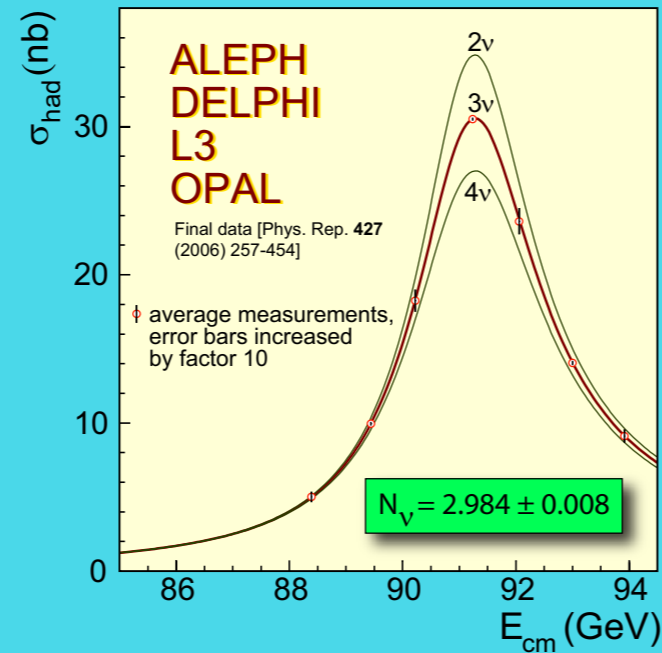

- The CMB spectrum (Planck)

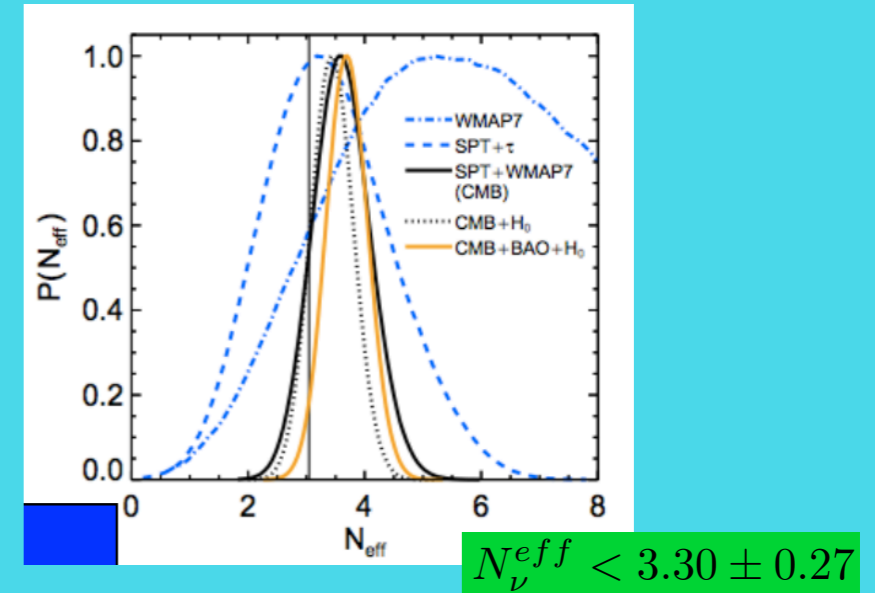

- Why 3 copies?

- The necessary condition for the baryon asymmetry of the Universe - CP violation
- CP in the SM comes from the non-zero phase in the quark (and lepton) mixing matrices
- Non-zero phase appears only if the number of generations $N \geq 3$

$$K = \begin{pmatrix} V_{ud} & V_{us} & V_{ub} \\ V_{cd} & V_{cs} & V_{cb} \\ V_{td} & V_{ts} & V_{tb} \end{pmatrix} = \begin{pmatrix} c_{12}c_{13} & s_{12}c_{13} & s_{13}e^{-i\delta} \\ -s_{12}c_{23} - c_{12}s_{23}s_{13}e^{i\delta} & c_{12}c_{23} - s_{12}s_{23}s_{13}e^{i\delta} & s_{23}c_{13} \\ s_{12}s_{23} - c_{12}c_{23}s_{13}e^{i\delta} & -c_{12}s_{23} - s_{12}c_{23}s_{13}e^{i\delta} & c_{23}c_{13} \end{pmatrix}$$

- The fourth generation is excluded also by precision measurement of rare decays

The Mass Spectrum and Mixing

The Mass Spectrum and Mixing

- Mass spectrum?

The Mass Spectrum and Mixing

- Mass spectrum?

$$m_{quark} = y_{quark} \cdot v$$

$$m_{lepton} = y_{lepton} \cdot v$$

$$m_W = g/\sqrt{2} \cdot v$$

$$m_Z = \sqrt{g^2 + g'^2}/\sqrt{2} \cdot v$$

$$m_H = \sqrt{\lambda} \cdot v$$

SM

$$m_\gamma = 0$$

$$m_{gluon} = 0$$

The Mass Spectrum and Mixing

- Mass spectrum?

$$m_{quark} = y_{quark} \cdot v$$

$$m_{lepton} = y_{lepton} \cdot v$$

$$m_W = g/\sqrt{2} \cdot v$$

$$m_Z = \sqrt{g^2 + g'^2}/\sqrt{2} \cdot v$$

$$m_H = \sqrt{\lambda} \cdot v$$

SM $m_\gamma = 0$

$m_{gluon} = 0$

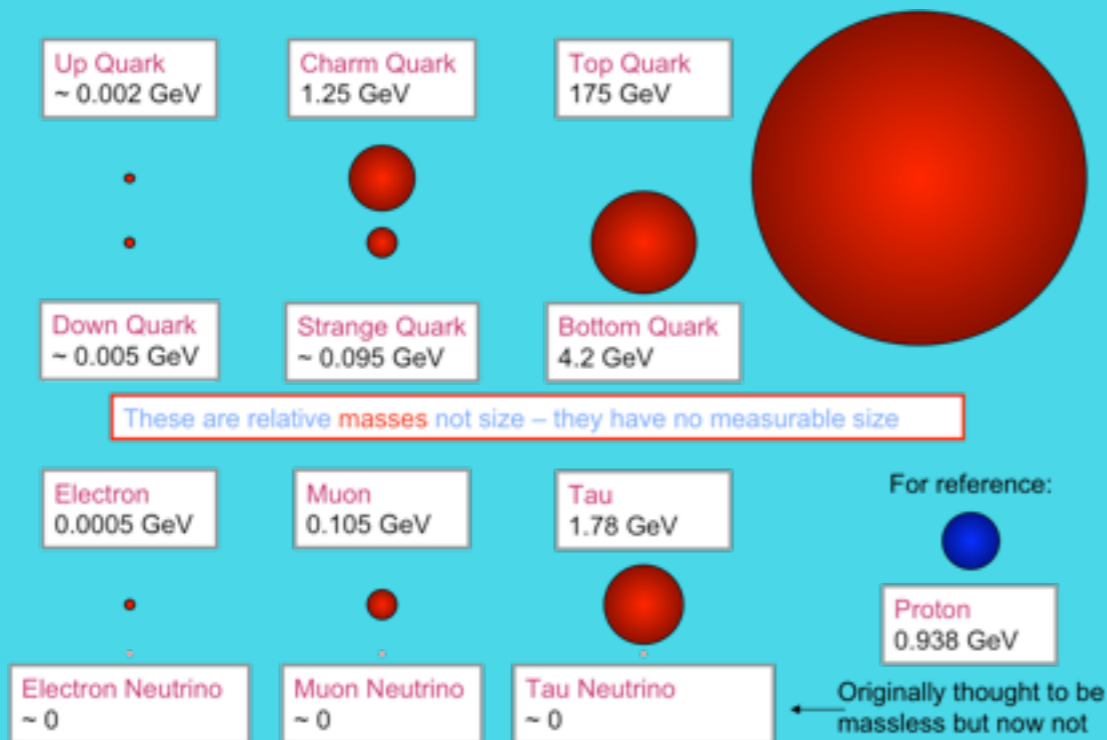

The Mass Spectrum and Mixing

- Mass spectrum?

- Mixing Matrices?

$$m_{quark} = y_{quark} \cdot v$$

$$m_{lepton} = y_{lepton} \cdot v$$

$$m_W = g/\sqrt{2} \cdot v$$

$$m_Z = \sqrt{g^2 + g'^2}/\sqrt{2} \cdot v$$

$$m_H = \sqrt{\lambda} \cdot v$$

SM $m_\gamma = 0$

$m_{gluon} = 0$

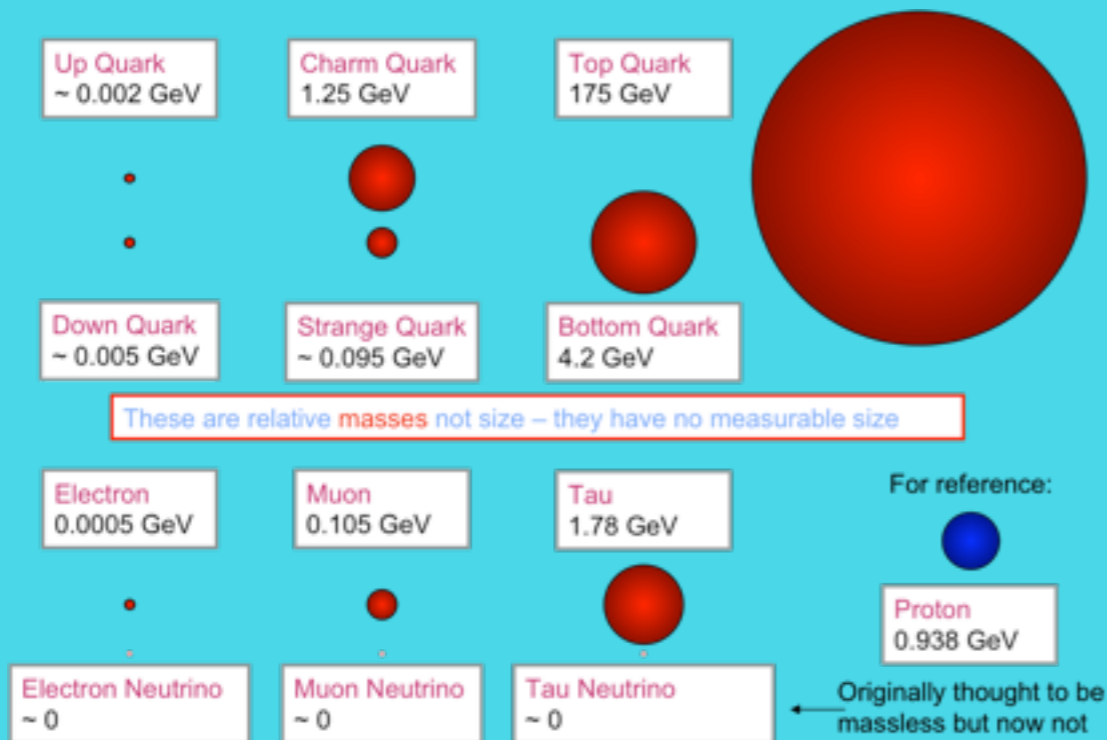

The Mass Spectrum and Mixing

- Mass spectrum?

- Mixing Matrices?

- Quark-Lepton Symmetry

$$m_{quark} = y_{quark} \cdot v$$
$$m_{lepton} = y_{lepton} \cdot v$$
$$m_W = g/\sqrt{2} \cdot v$$
$$m_Z = \sqrt{g^2 + g'^2}/\sqrt{2} \cdot v$$
$$m_H = \sqrt{\lambda} \cdot v$$

SM $m_\gamma = 0$

$$m_{gluon} = 0$$

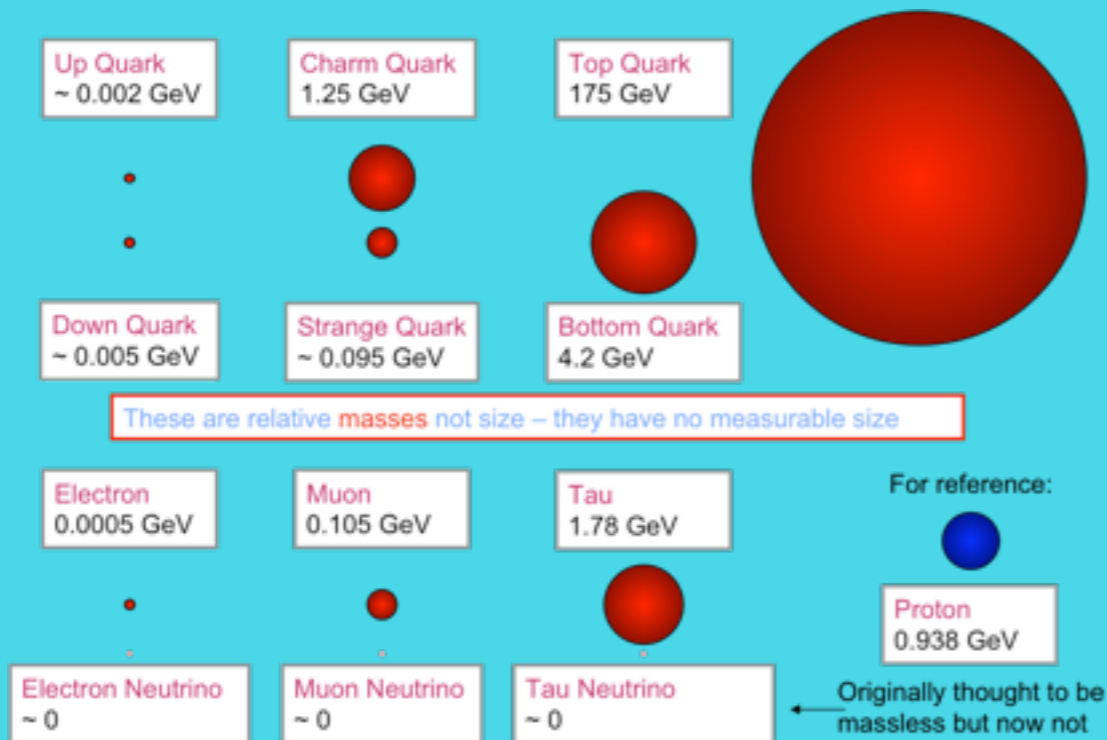

The Mass Spectrum and Mixing

- Mass spectrum?

$$m_{quark} = y_{quark} \cdot v$$

$$m_{lepton} = y_{lepton} \cdot v$$

$$m_W = g/\sqrt{2} \cdot v$$

$$m_Z = \sqrt{g^2 + g'^2}/\sqrt{2} \cdot v$$

$$m_H = \sqrt{\lambda} \cdot v$$

SM $m_\gamma = 0$

$m_{gluon} = 0$

- Mixing Matrices?

- Quark-Lepton Symmetry
- Strong difference in parameters

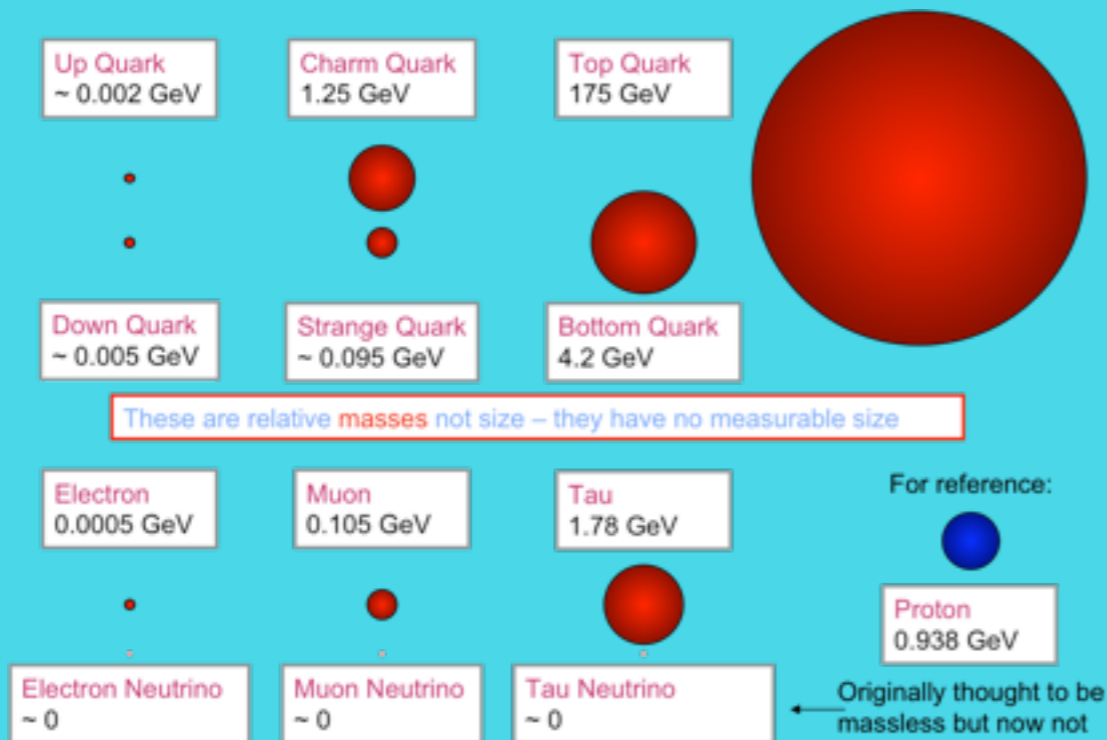

The Mass Spectrum and Mixing

- Mass spectrum?

$$m_{quark} = y_{quark} \cdot v$$

$$m_{lepton} = y_{lepton} \cdot v$$

$$m_W = g/\sqrt{2} \cdot v$$

$$m_Z = \sqrt{g^2 + g'^2}/\sqrt{2} \cdot v$$

$$m_H = \sqrt{\lambda} \cdot v$$

SM $m_\gamma = 0$

$m_{gluon} = 0$

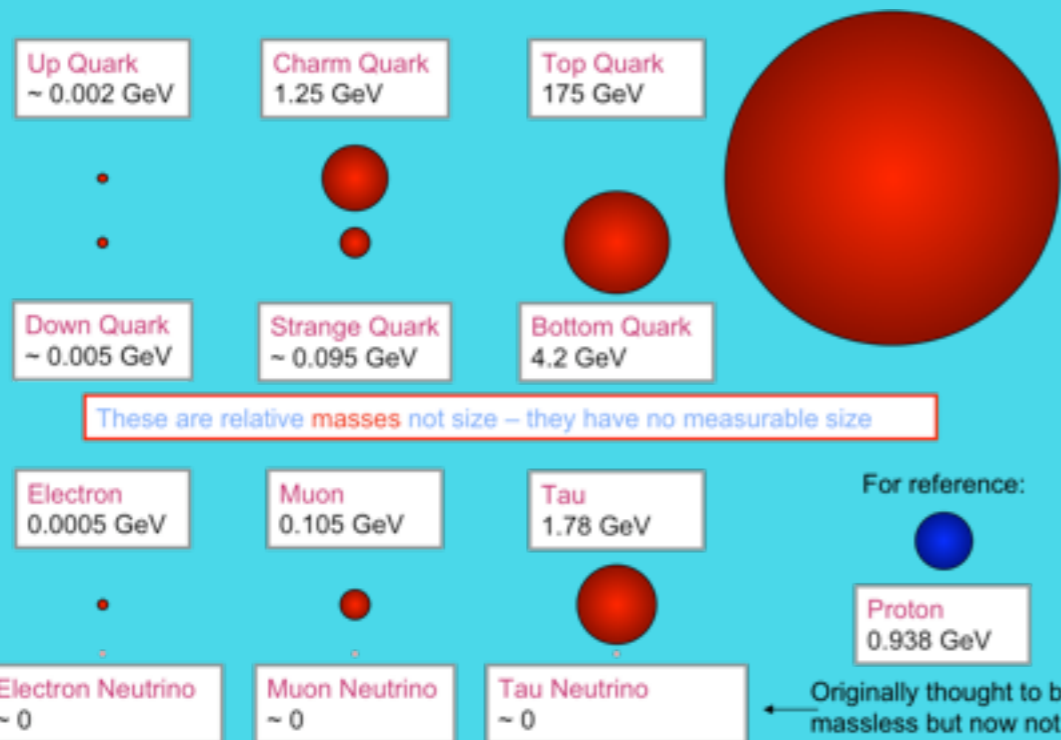

- Mixing Matrices?

- Quark-Lepton Symmetry
- Strong difference in parameters

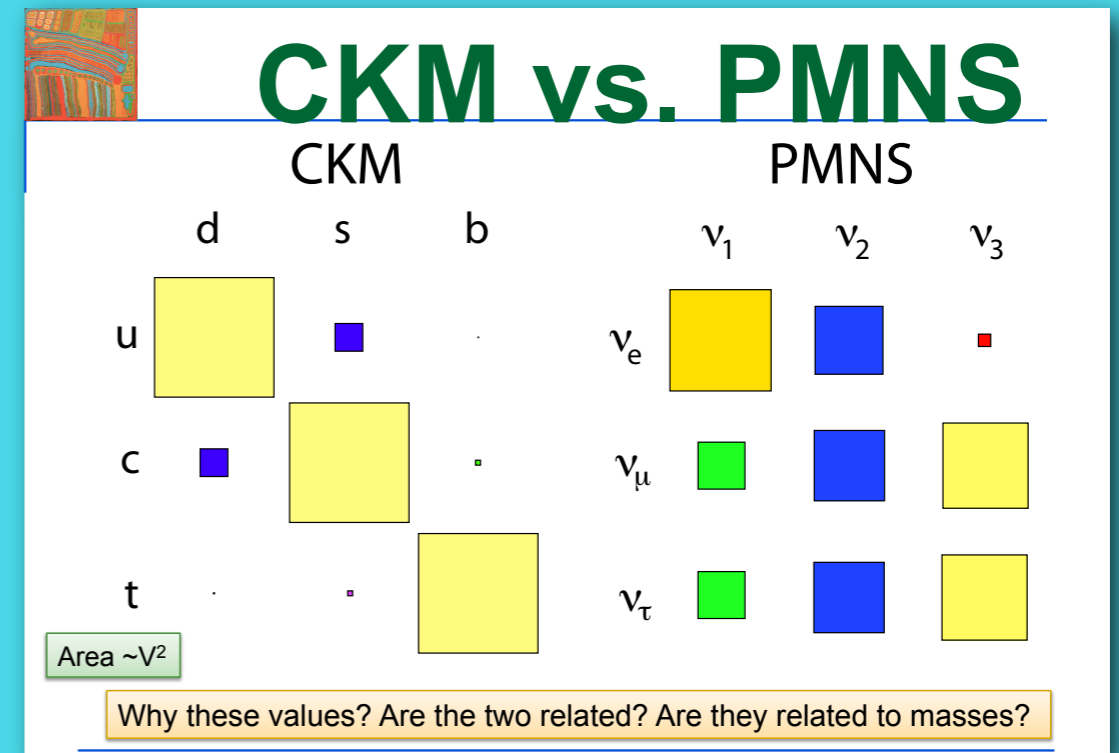

The Mass Spectrum and Mixing

- Mass spectrum?

$$m_{quark} = y_{quark} \cdot v$$

$$m_{lepton} = y_{lepton} \cdot v$$

$$m_W = g/\sqrt{2} \cdot v$$

$$m_Z = \sqrt{g^2 + g'^2}/\sqrt{2} \cdot v$$

$$m_H = \sqrt{\lambda} \cdot v$$

SM $m_\gamma = 0$

$m_{gluon} = 0$

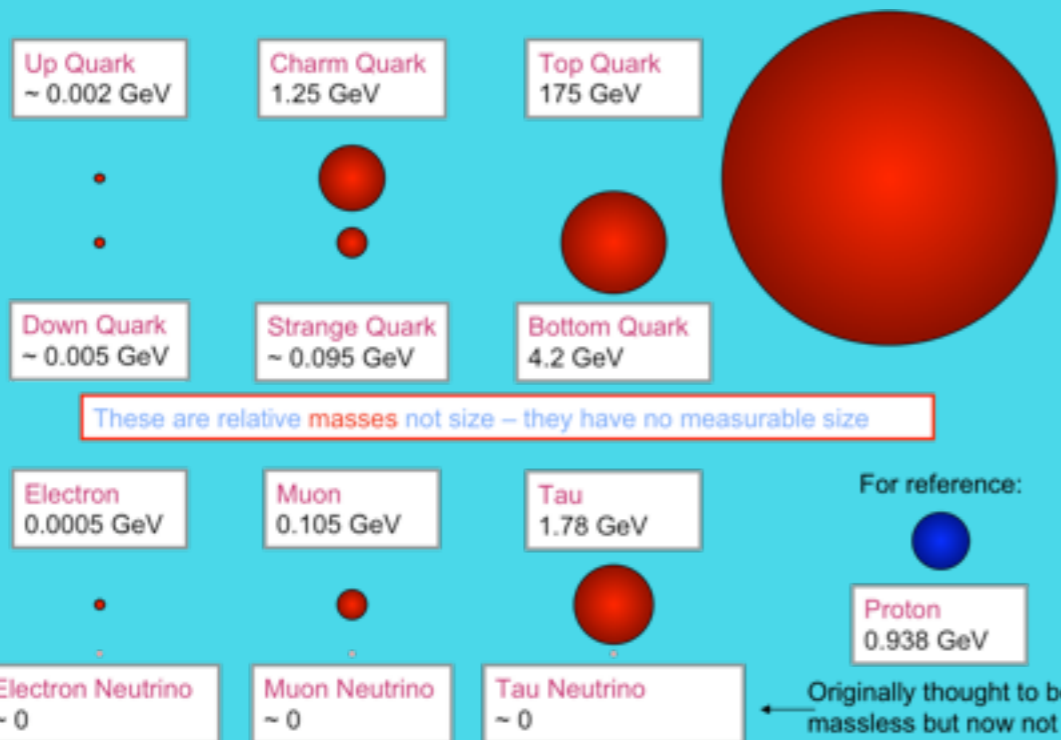

- Mixing Matrices?

- Quark-Lepton Symmetry
- Strong difference in parameters

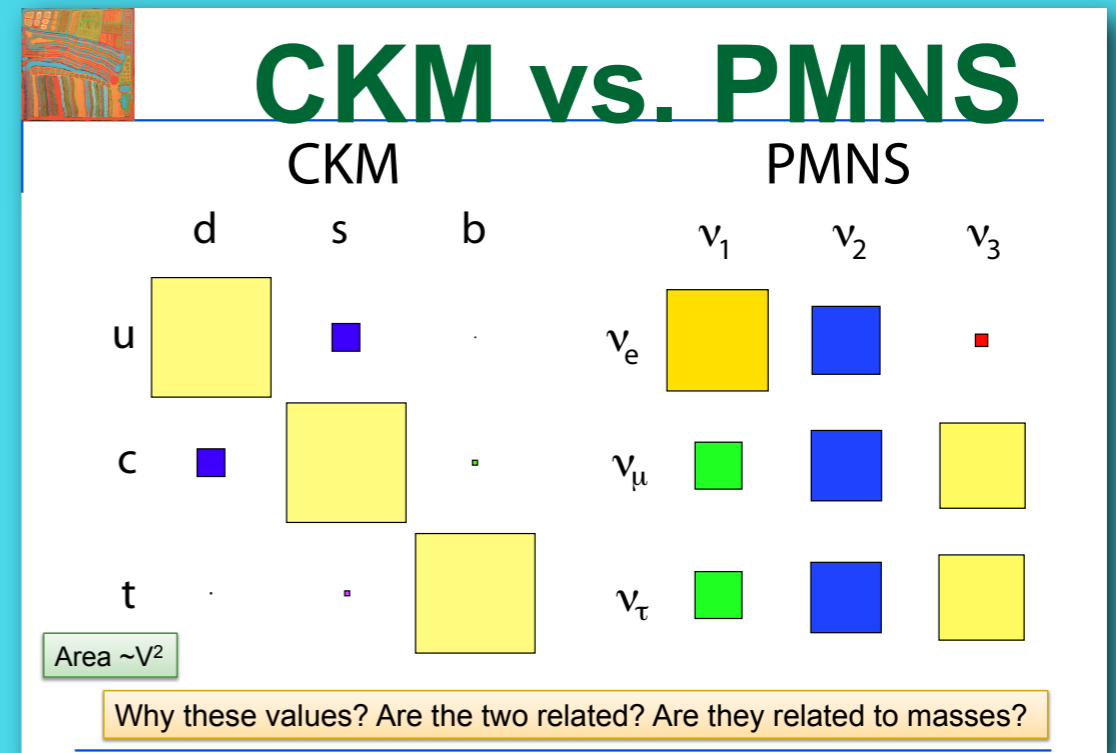

- What re the CKM and PMNS phases?

The Mass Spectrum and Mixing

- Mass spectrum?

$$m_{quark} = y_{quark} \cdot v$$

$$m_{lepton} = y_{lepton} \cdot v$$

$$m_W = g/\sqrt{2} \cdot v$$

$$m_Z = \sqrt{g^2 + g'^2}/\sqrt{2} \cdot v$$

$$m_H = \sqrt{\lambda} \cdot v$$

SM $m_\gamma = 0$

$m_{gluon} = 0$

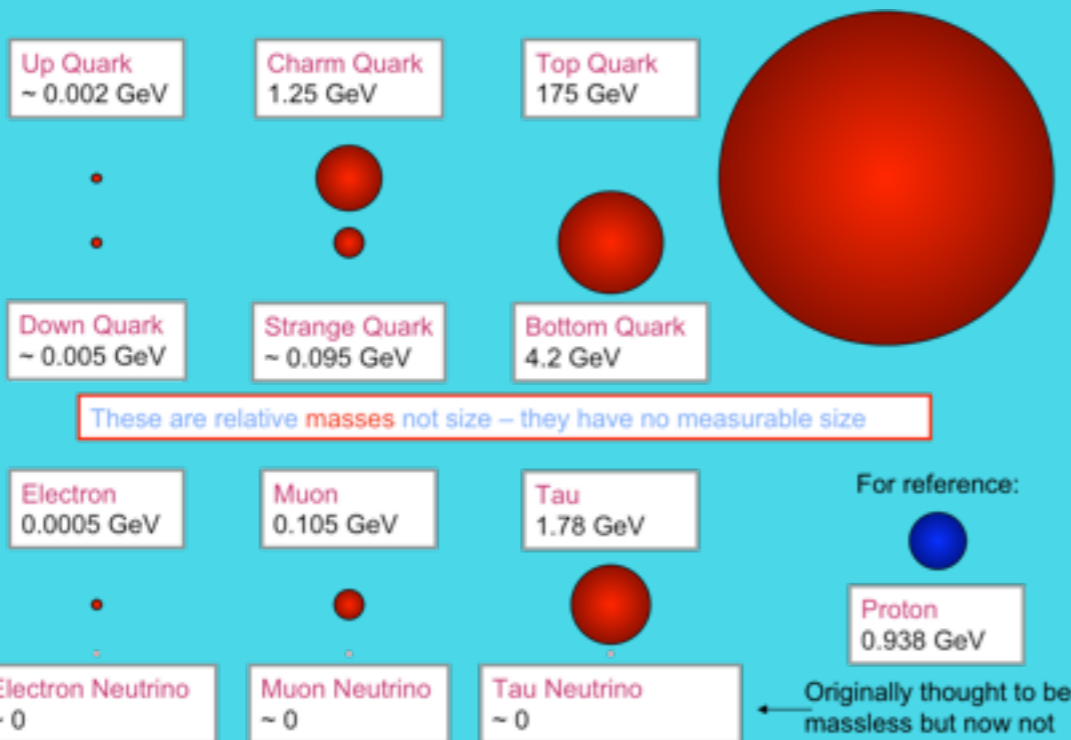

- Mixing Matrices?

- Quark-Lepton Symmetry
- Strong difference in parameters

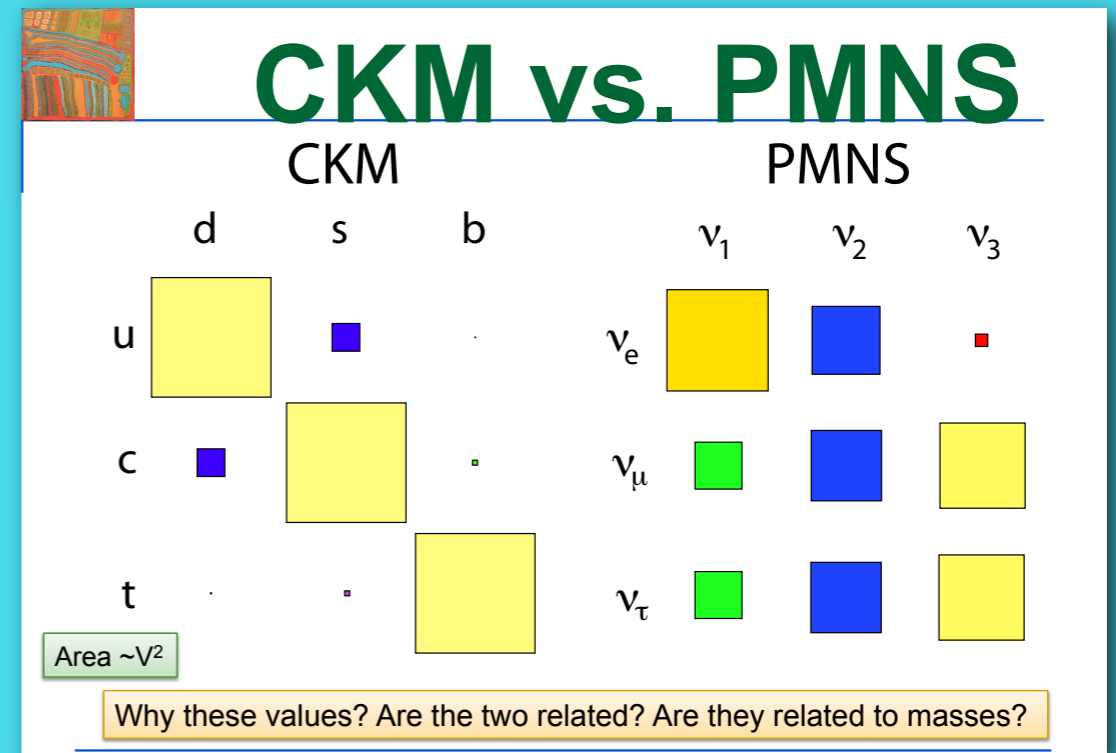

- What re the CKM and PMNS phases?
- Where lies the source of CP violation: in quark or lepton sector?

Dark Matter

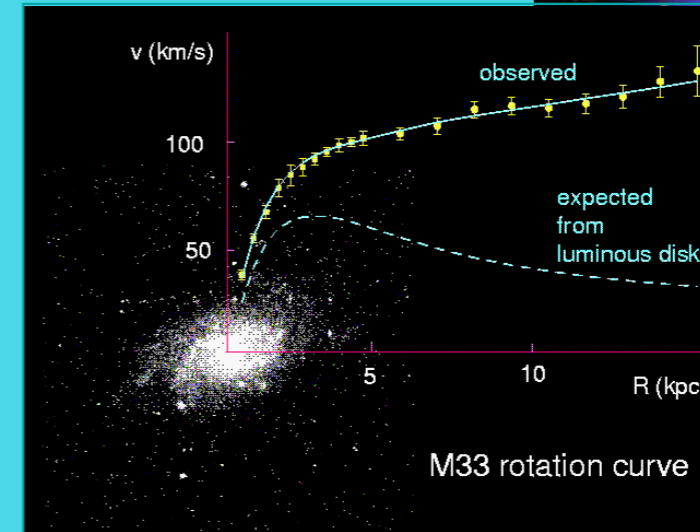
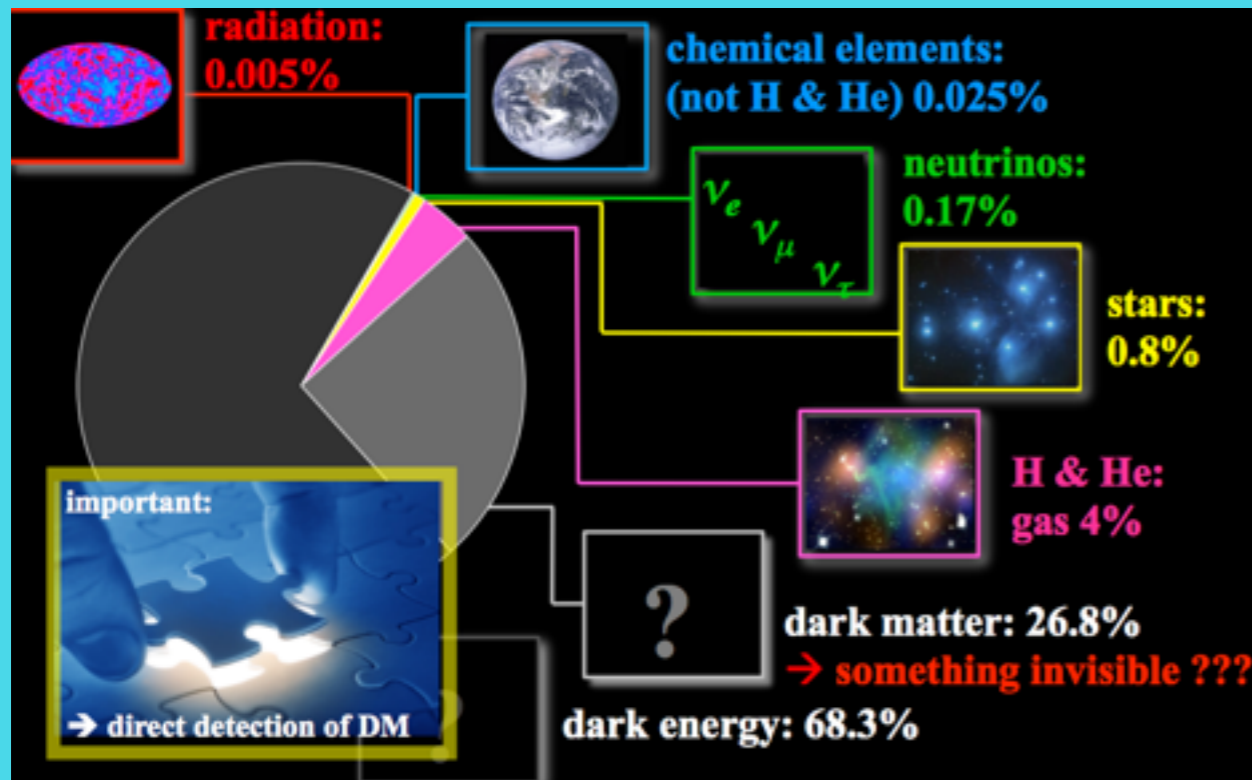
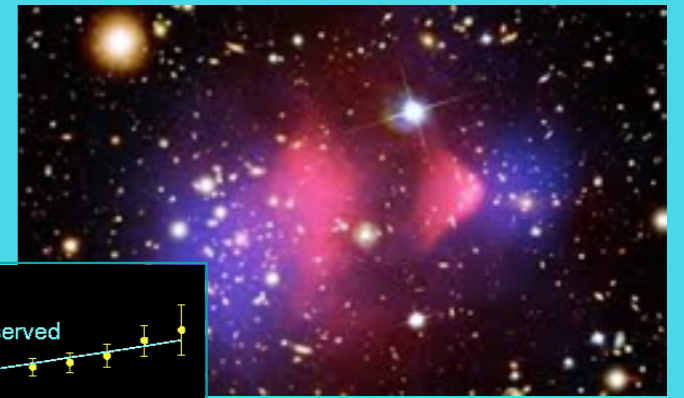

- rotation curves of stars
- gravitational lensing
- large scale structure of the Universe

Dark Matter

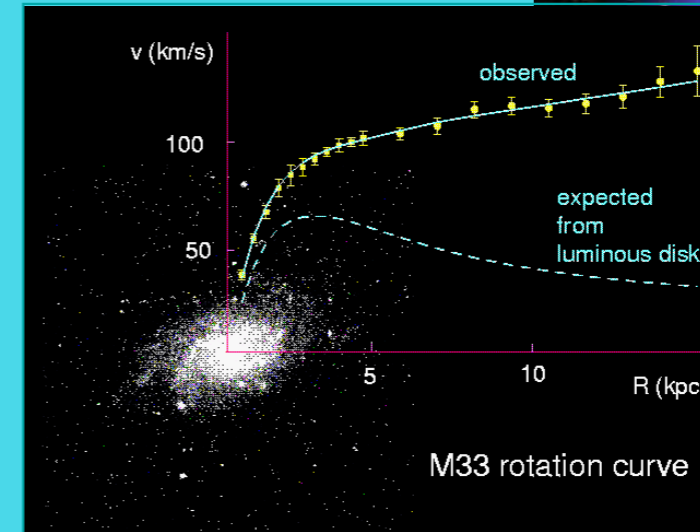
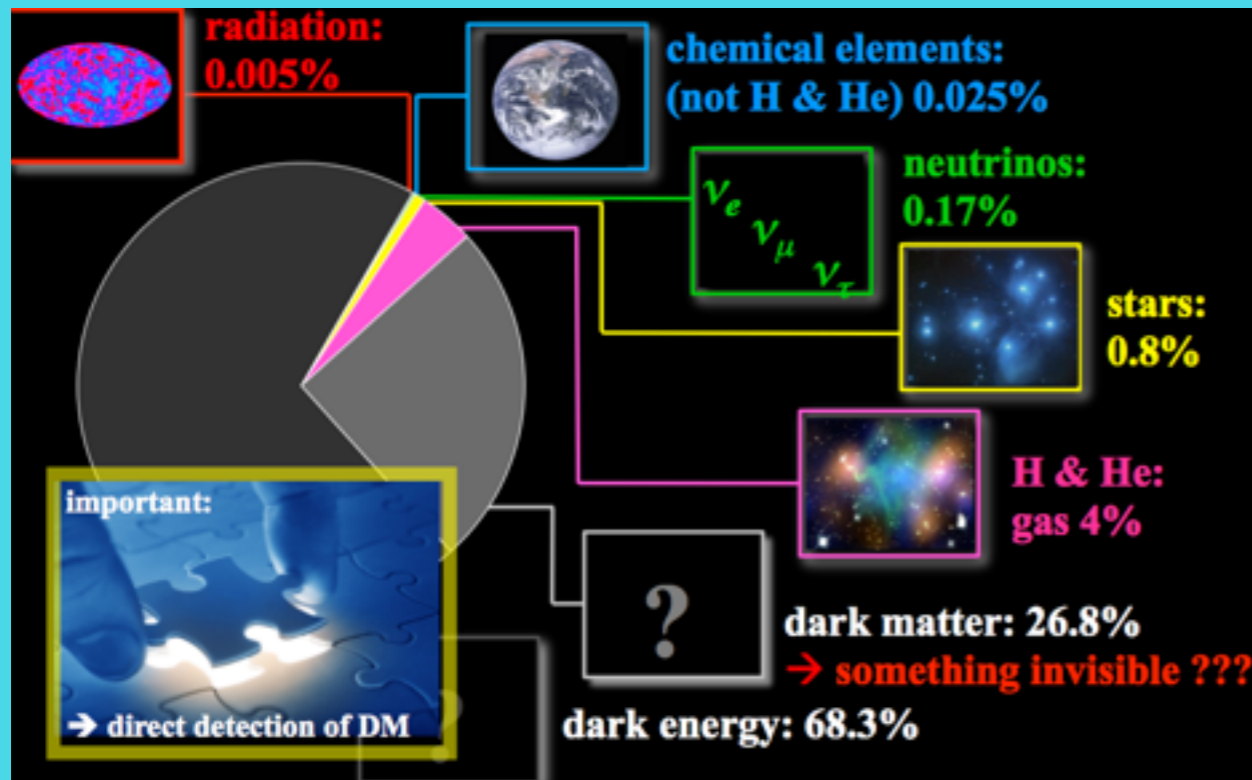
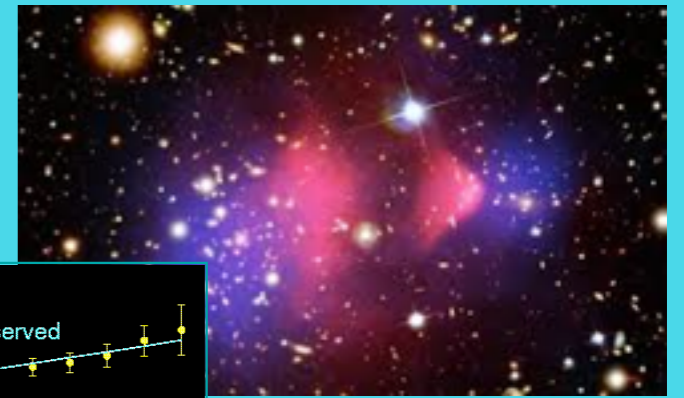

- rotation curves of stars
- gravitational lensing
- large scale structure of the Universe

Dark matter is made of:

- Macro objects- not observed
- New neutral particles

Dark Matter

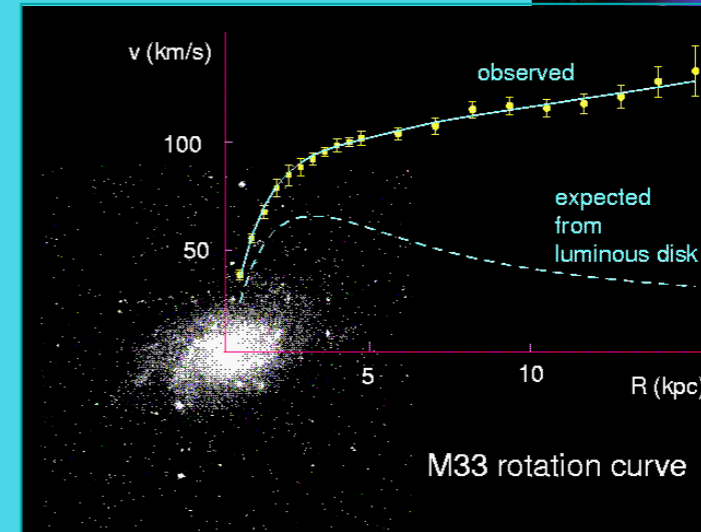
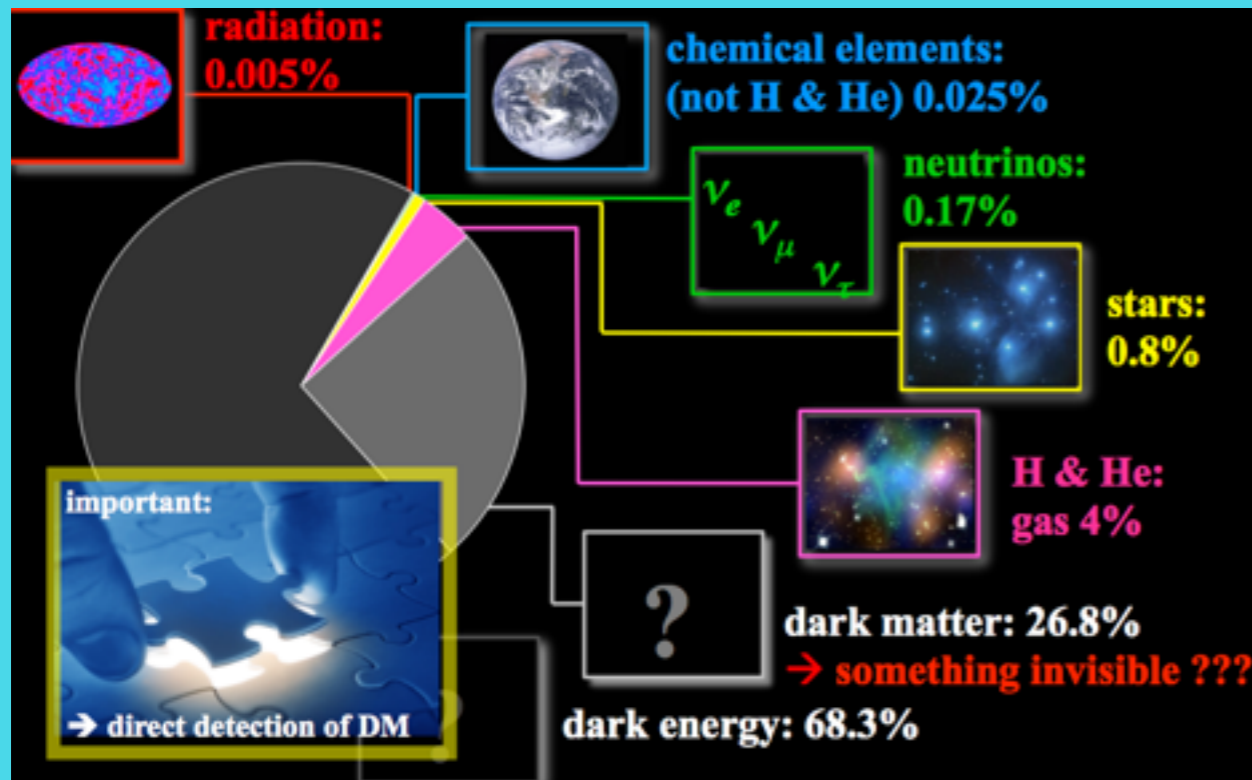
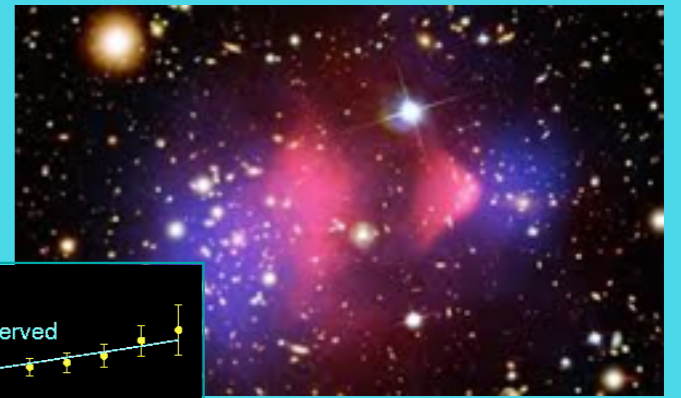

- rotation curves of stars
- gravitational lensing
- large scale structure of the Universe

WIMP = Weakly Interacting Massive Particle

A good argument for new physics at the TeV scale but not fully compelling: DM could well be **axions**

For WIMPs in thermal equilibrium after inflation

$$\langle \sigma_{\text{ann}} v \rangle \simeq 3 \times 10^{-26} \text{cm}^3 \text{s}^{-1}$$

EW x-section for particle with $M \sim 10^{2-3} \text{ GeV}$

Dark Matter

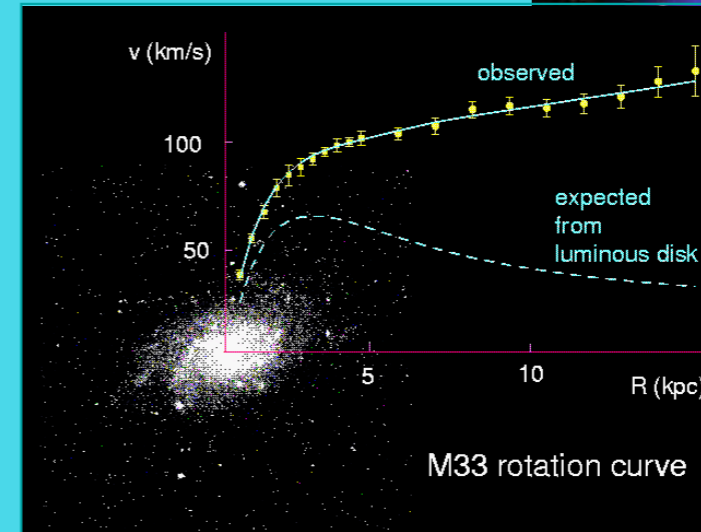
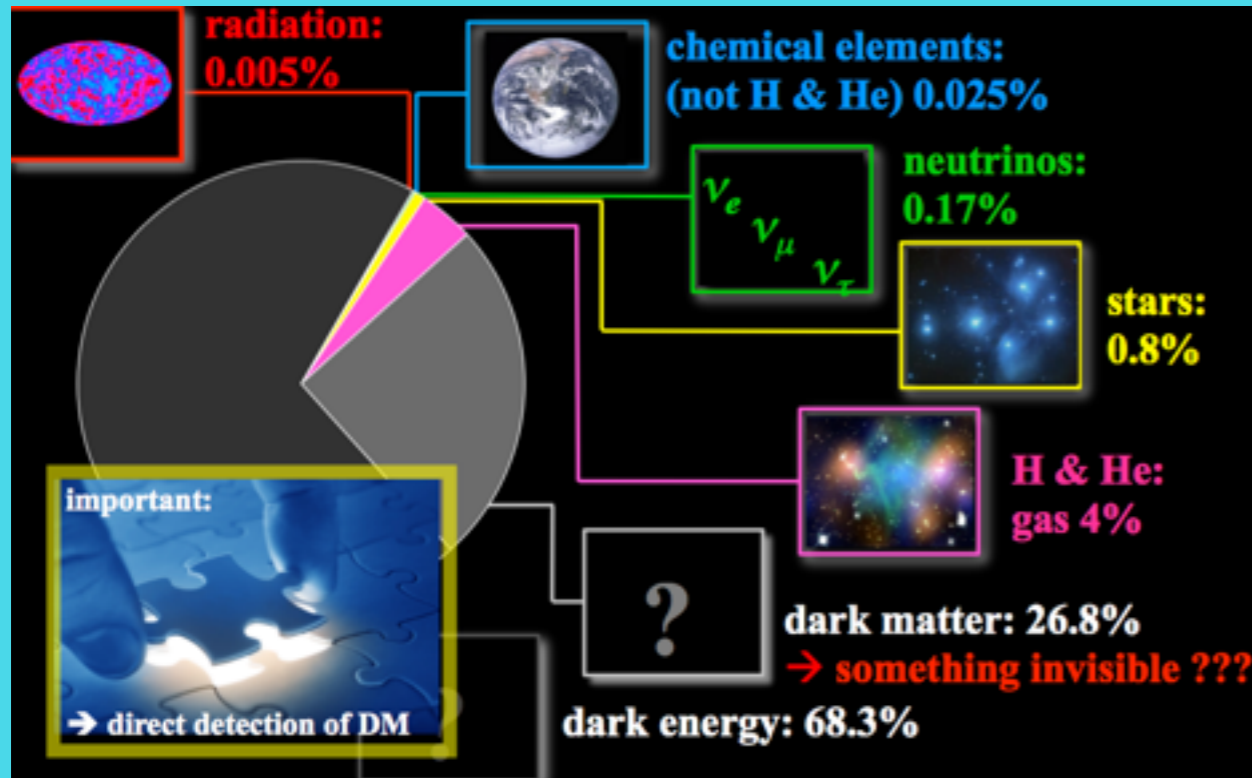
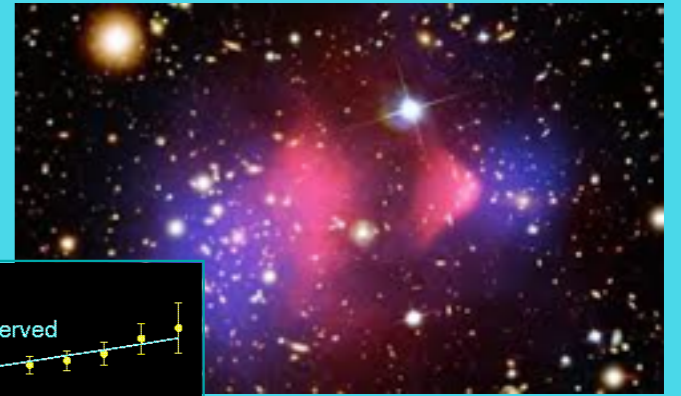

- rotation curves of stars
- gravitational lensing
- large scale structure of the Universe

Dark matter is made of:

- Macro objects- not observed
- New neutral particles

Dark Matter

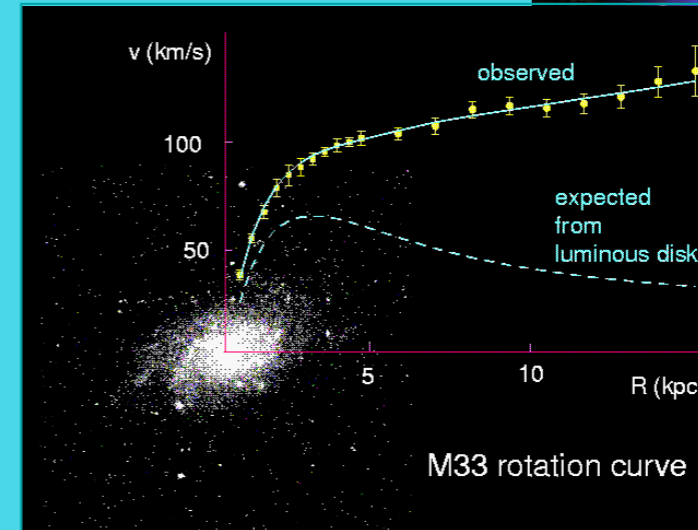
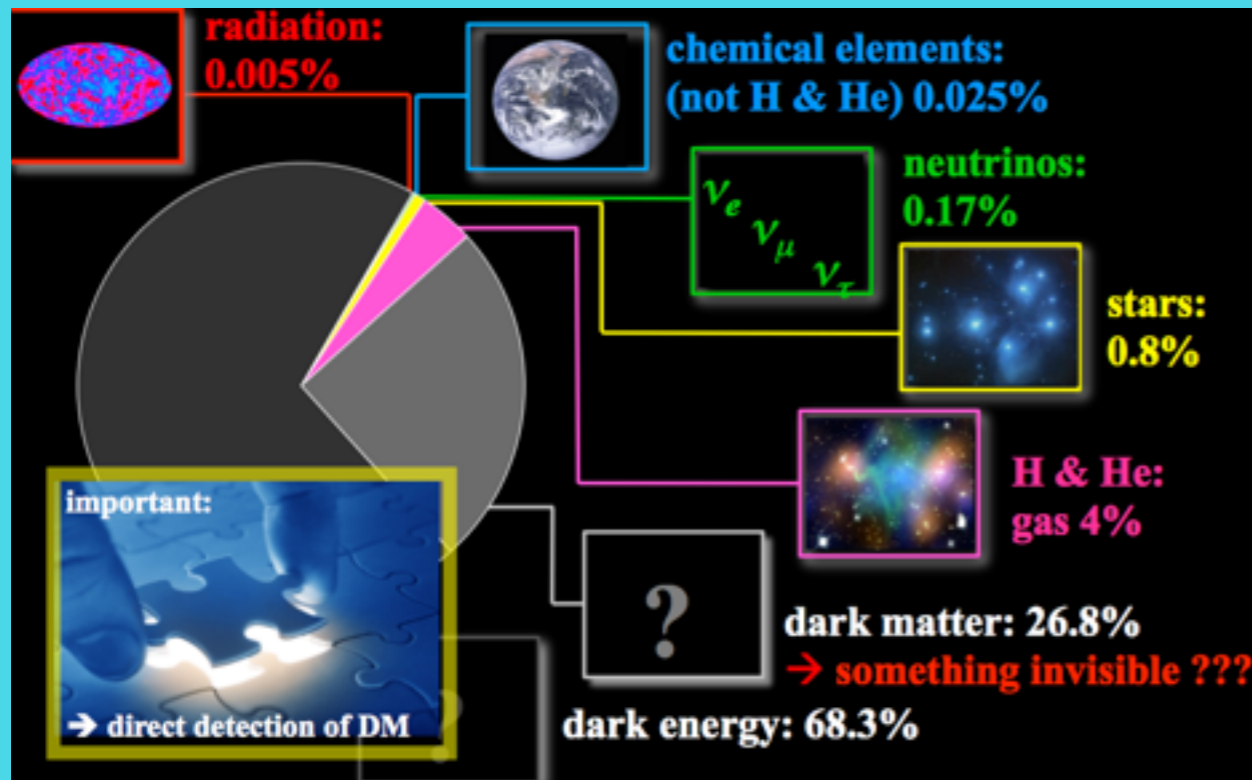
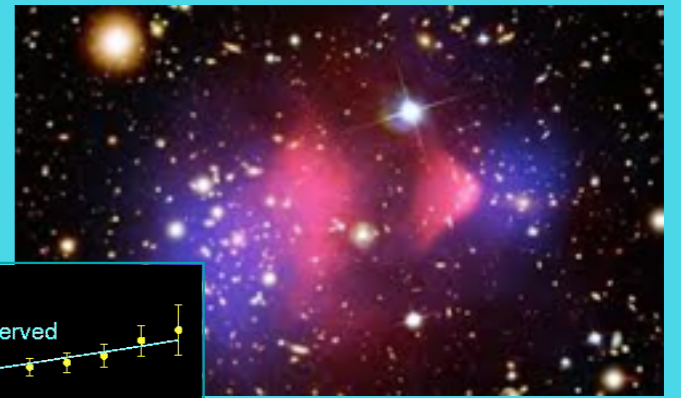

- rotation curves of stars
- gravitational lensing
- large scale structure of the Universe

Dark matter is made of:

- Macro objects- not observed
- New neutral particles
 - right-handed neutrino

Dark Matter

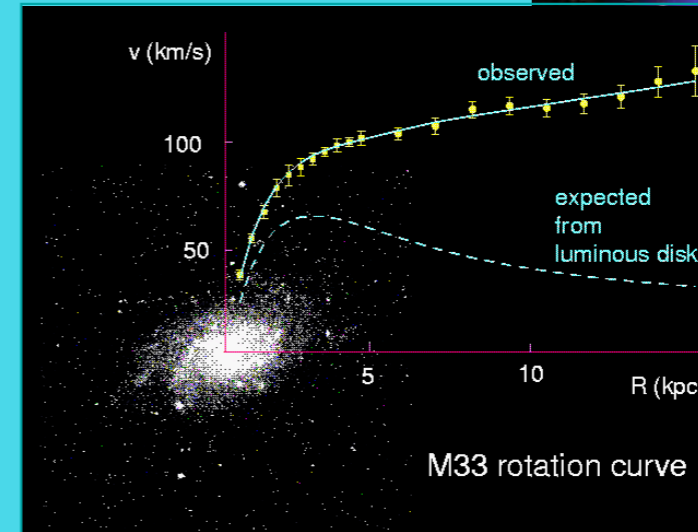
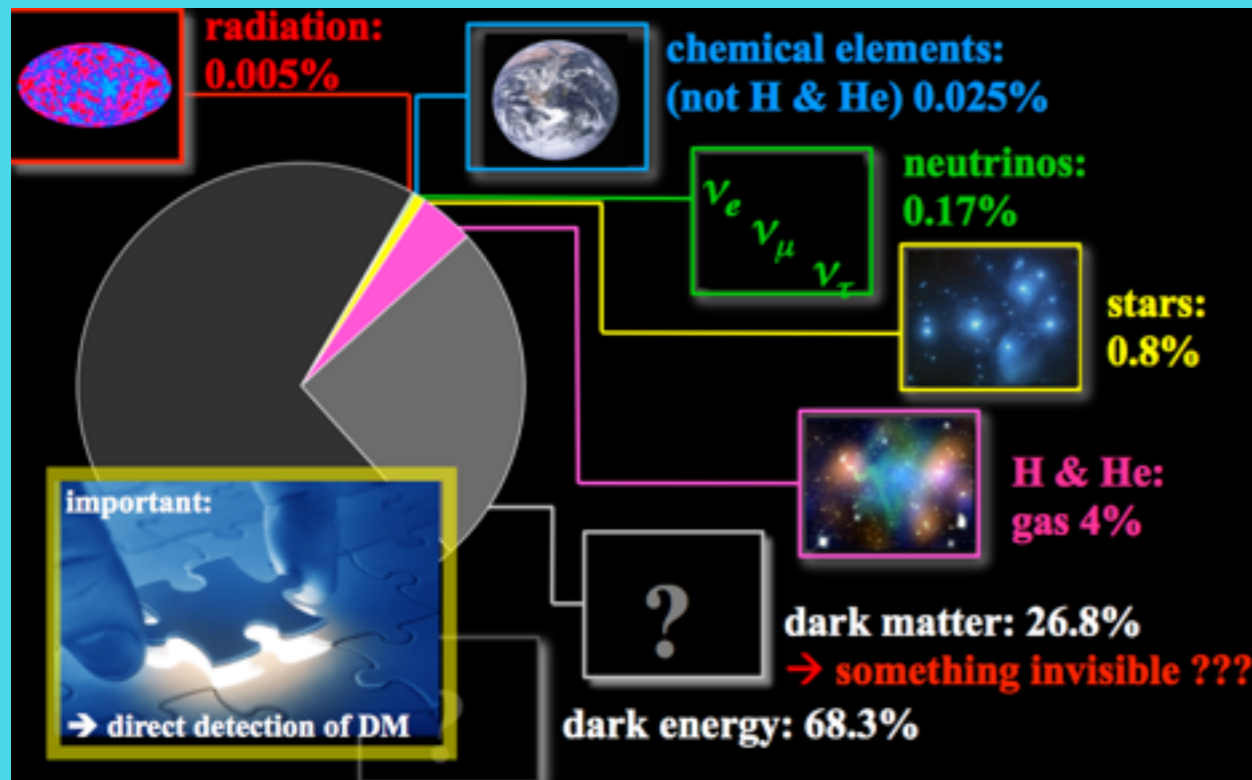
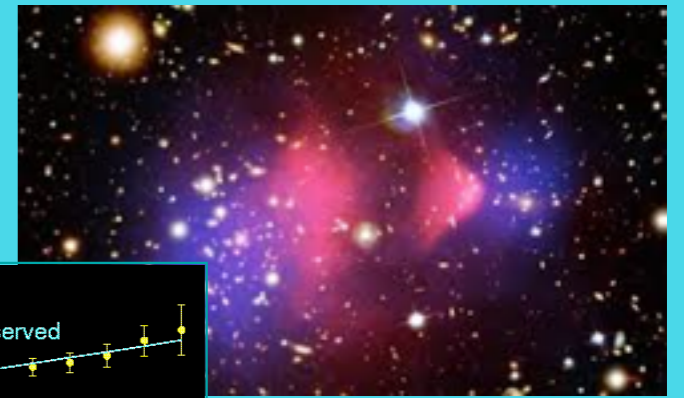

- rotation curves of stars
- gravitational lensing
- large scale structure of the Universe

Dark matter is made of:

- Macro objects- not observed
- New neutral particles
 - right-handed neutrino
 - neutralino

Dark Matter

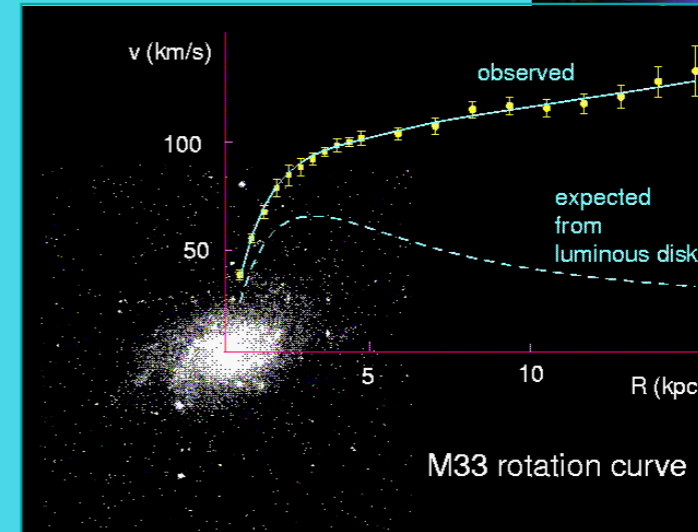
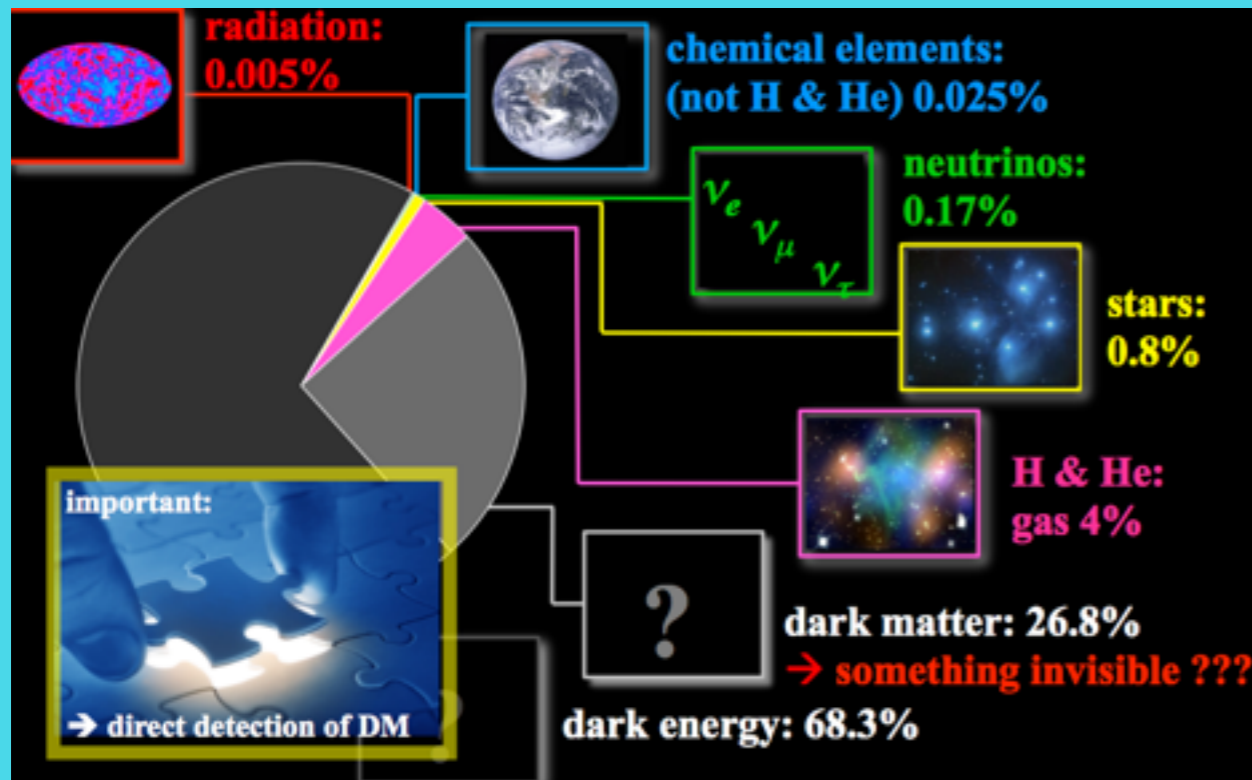
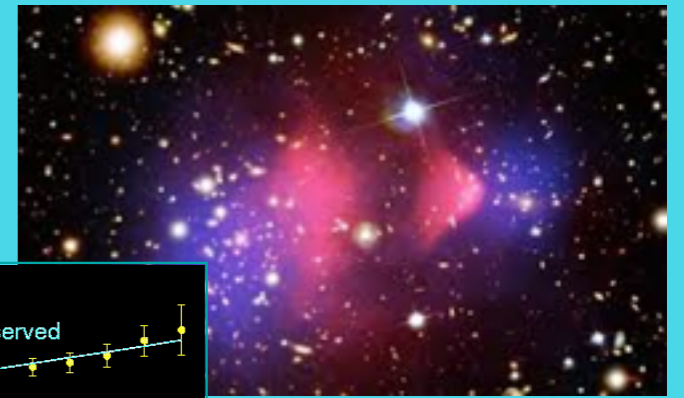

- rotation curves of stars
- gravitational lensing
- large scale structure of the Universe

Dark matter is made of:

- Macro objects- not observed
- New neutral particles
 - right-handed neutrino
 - neutralino
 - sneutrino

Dark Matter

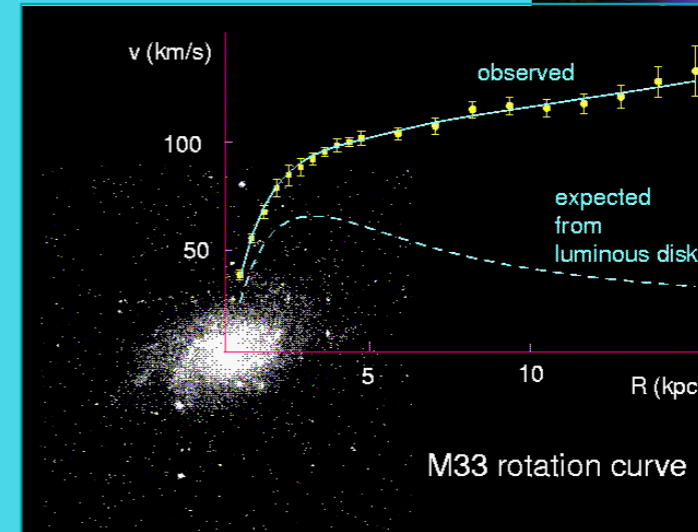
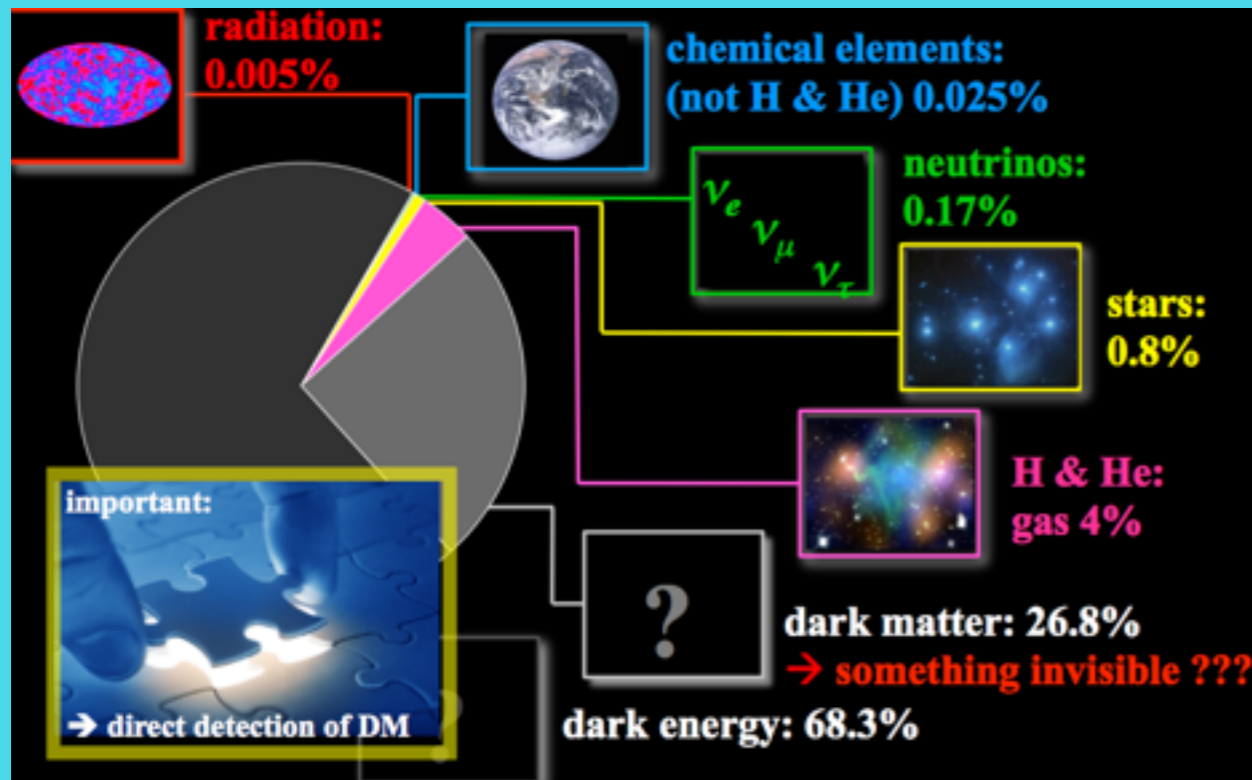
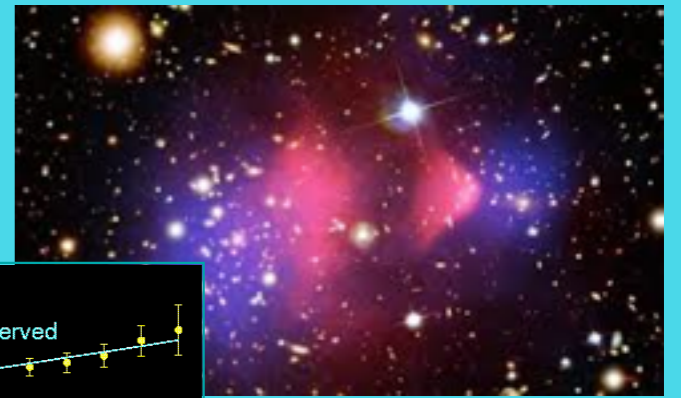

- rotation curves of stars
- gravitational lensing
- large scale structure of the Universe

Dark matter is made of:

- Macro objects- not observed
- New neutral particles
 - right-handed neutrino
 - neutralino
 - sneutrino
 - axion (axino)

Dark Matter

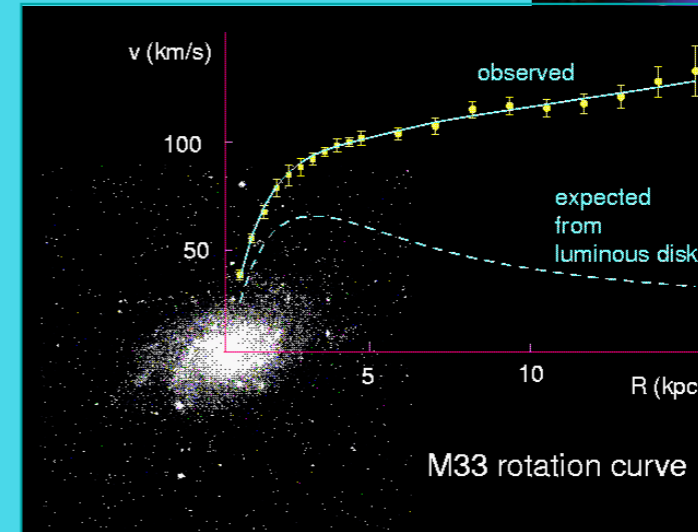
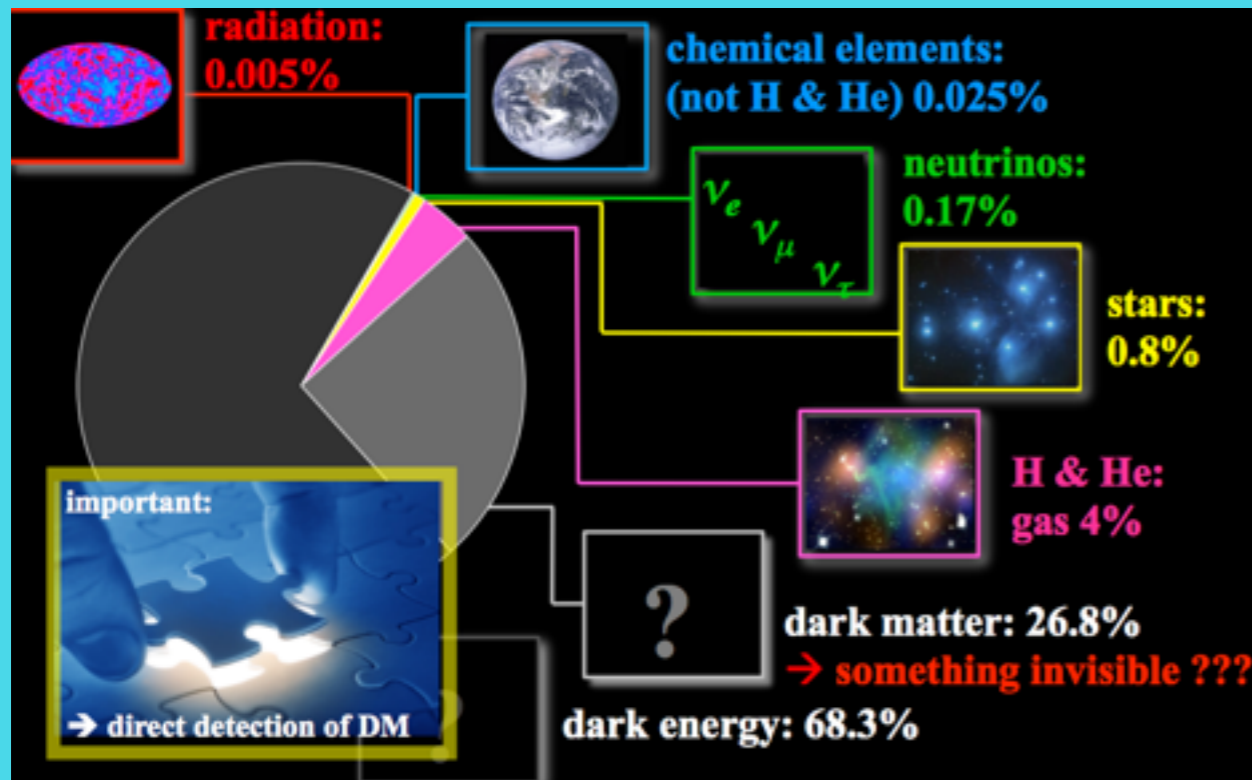
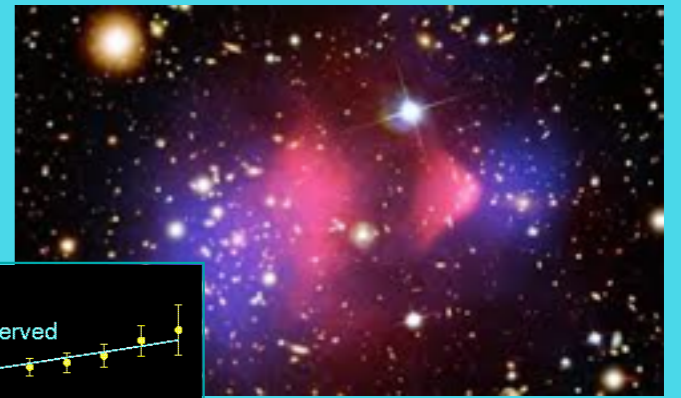

- rotation curves of stars
- gravitational lensing
- large scale structure of the Universe

Dark matter is made of:

- Macro objects- not observed
- New neutral particles
 - right-handed neutrino
 - neutralino
 - sneutrino
 - axion (axino)
 - gravitino

Dark Matter

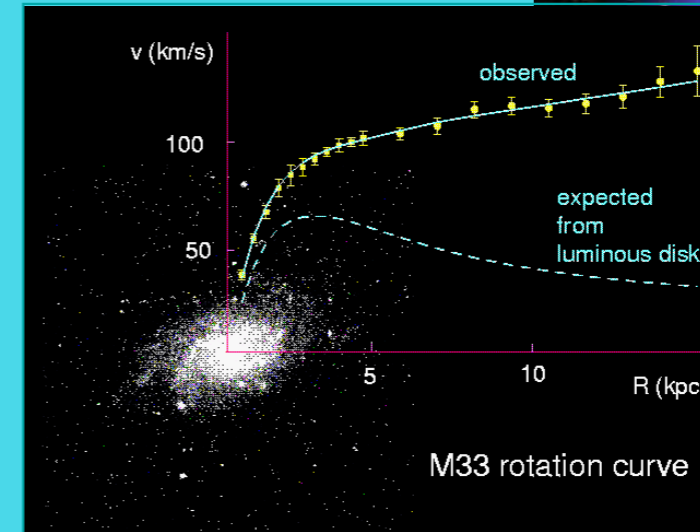
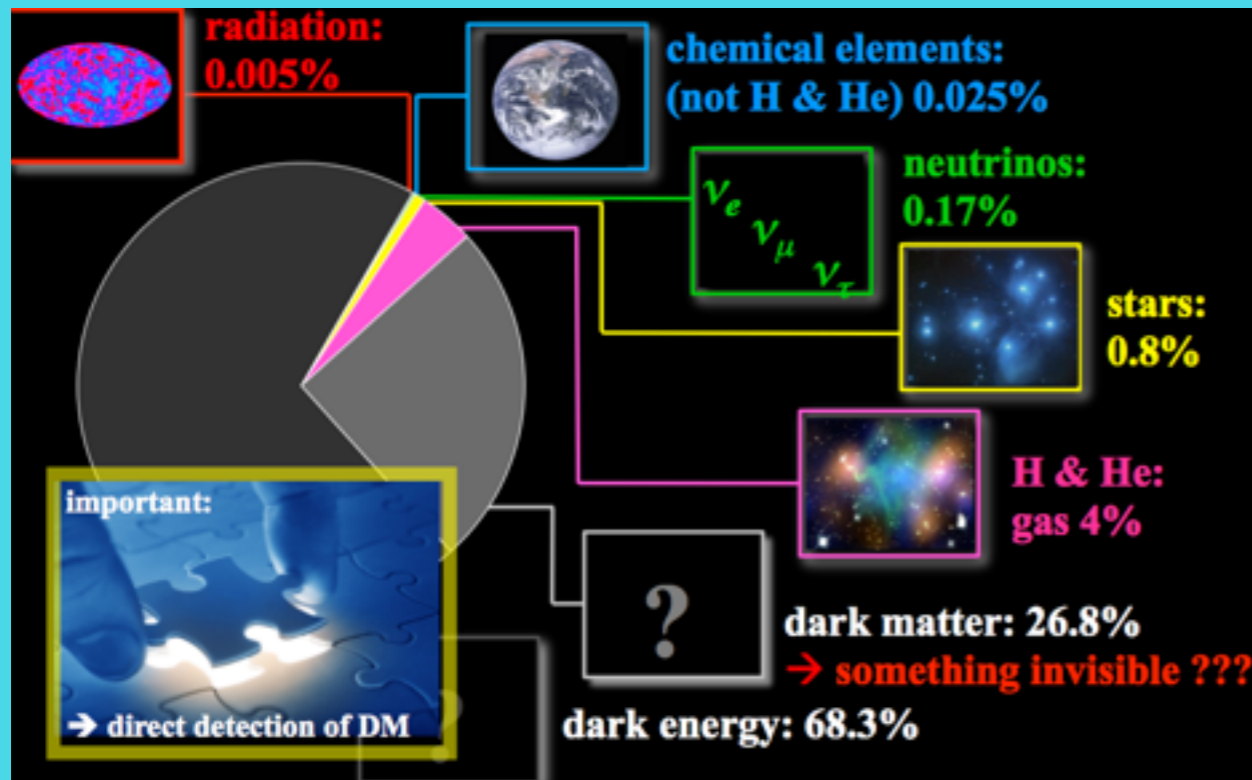
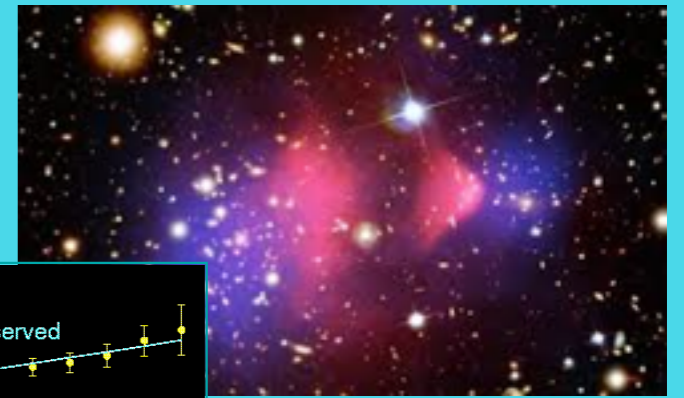

- rotation curves of stars
- gravitational lensing
- large scale structure of the Universe

Dark matter is made of:

- Macro objects- not observed
- New neutral particles
 - right-handed neutrino
 - neutralino
 - sneutrino
 - axion (axino)
 - gravitino
 - heavy photon

Dark Matter

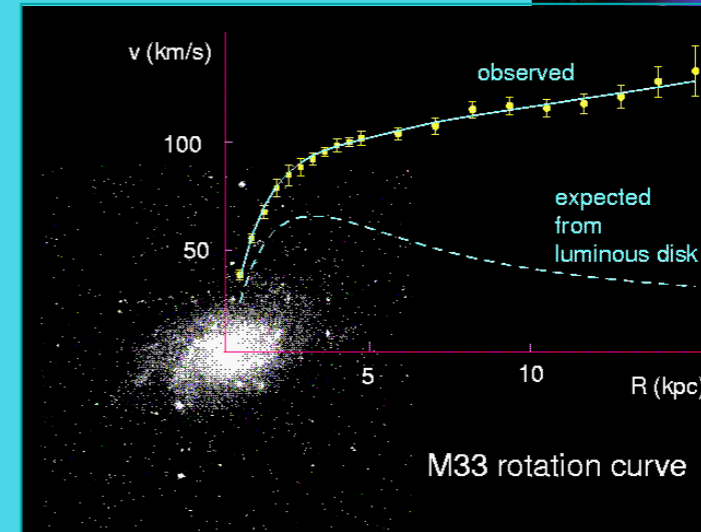
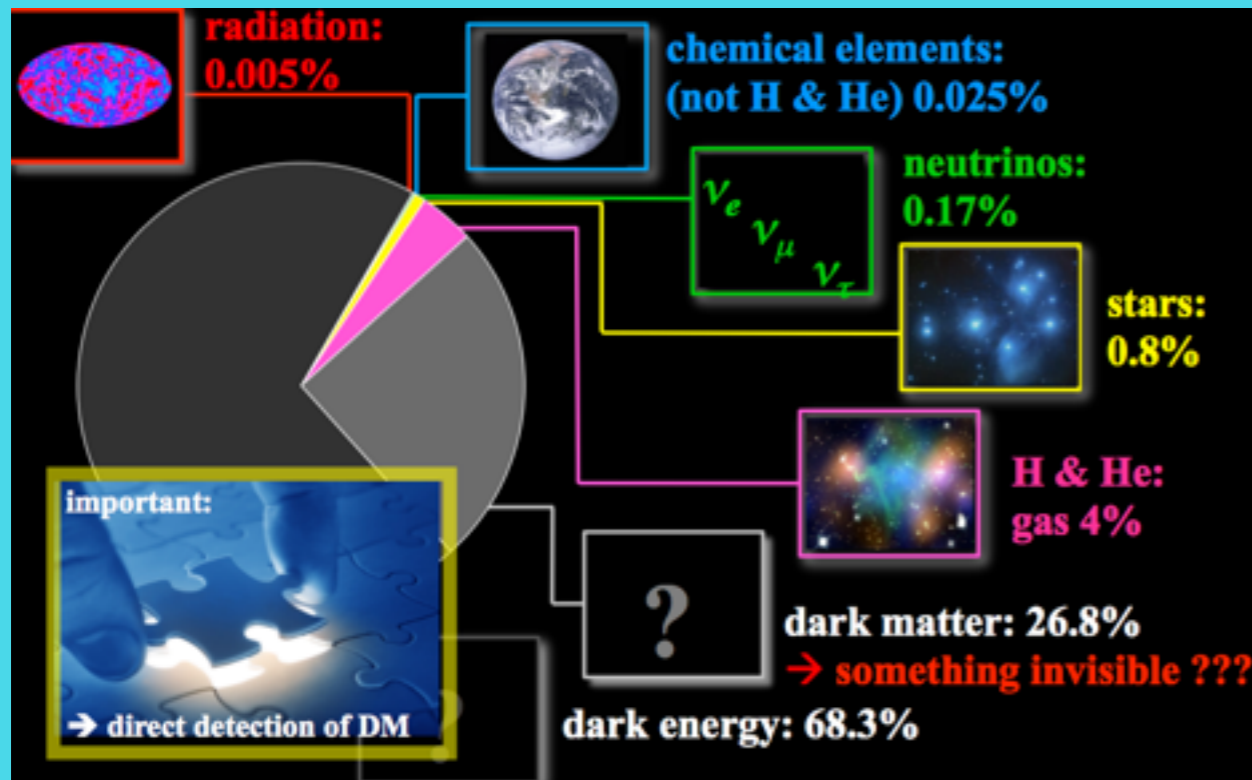
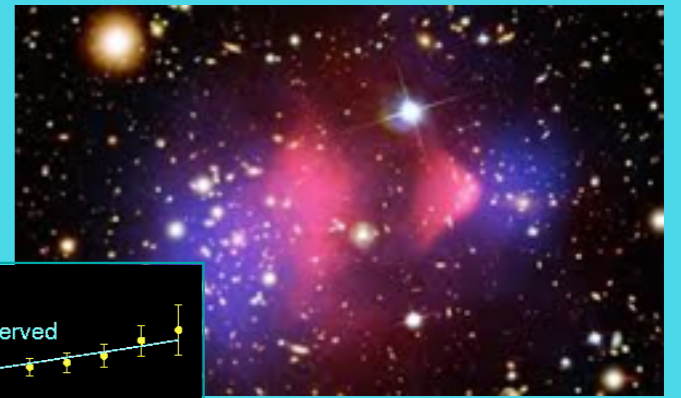

- rotation curves of stars
- gravitational lensing
- large scale structure of the Universe

Dark matter is made of:

- Macro objects- not observed
- New neutral particles
 - right-handed neutrino
 - neutralino
 - sneutrino
 - axion (axino)
 - gravitino
 - heavy photon
 - light sterile Higgs

Dark Matter

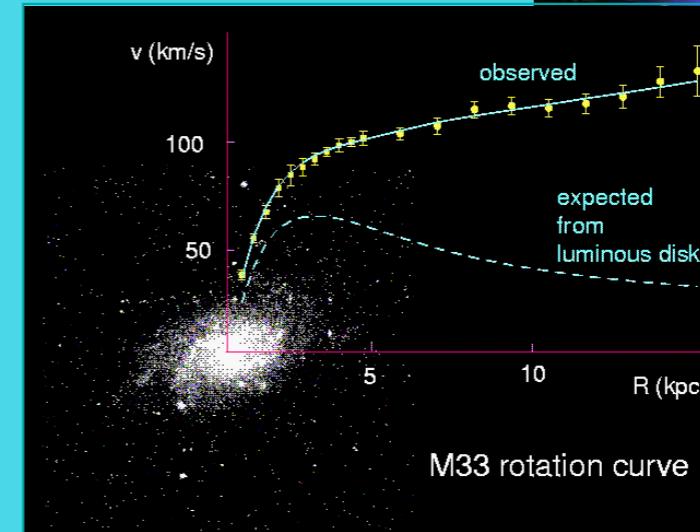
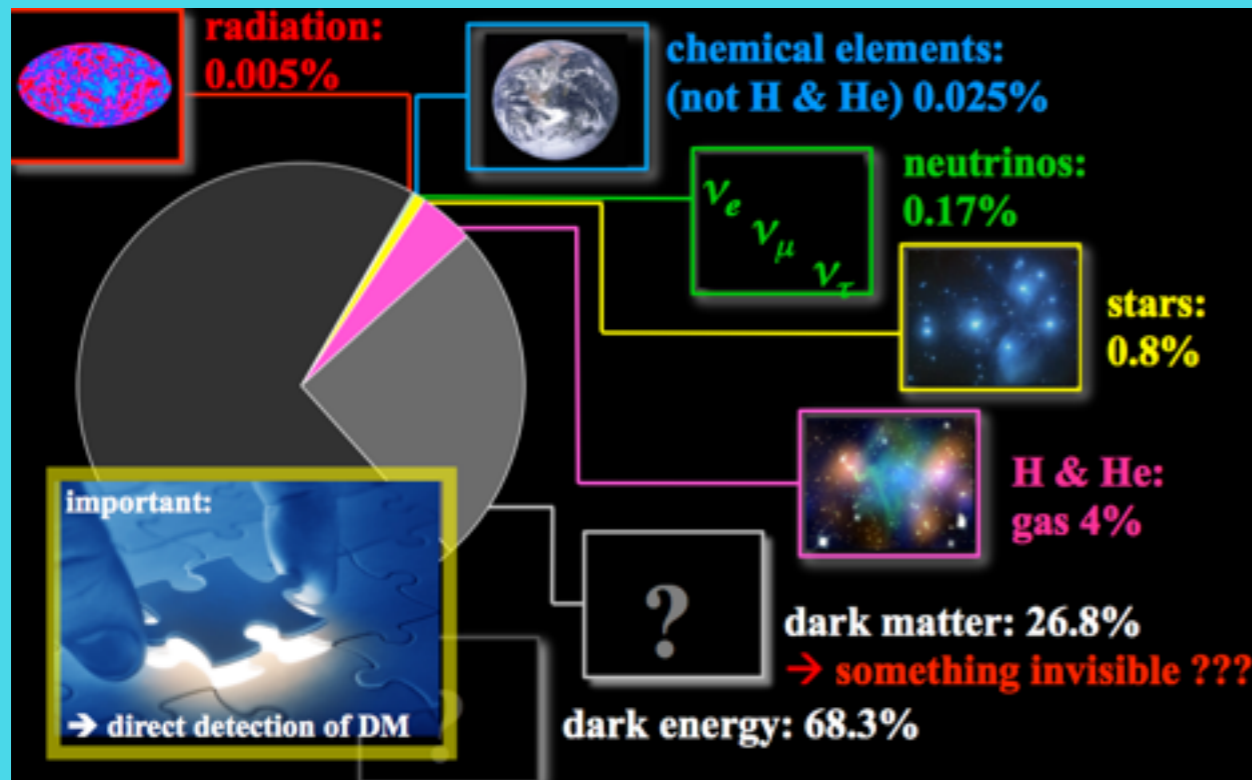
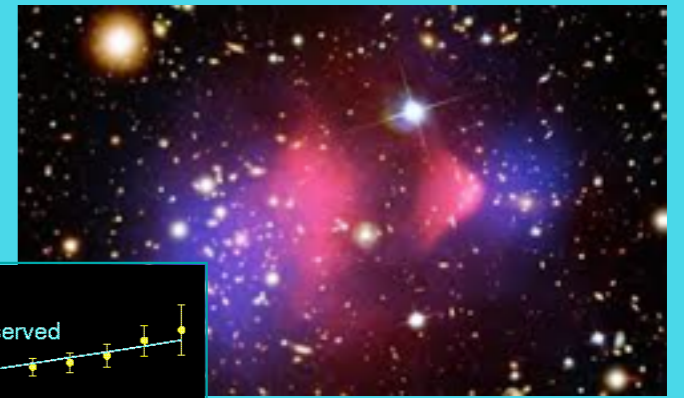

- rotation curves of stars
- gravitational lensing
- large scale structure of the Universe

Dark matter is made of:

- Macro objects- not observed
 - New neutral particles
- right-handed neutrino
 - neutralino
 - sneutrino
 - axion (axino)
 - gravitino
 - heavy photon
 - light sterile Higgs
- ?

Dark Matter

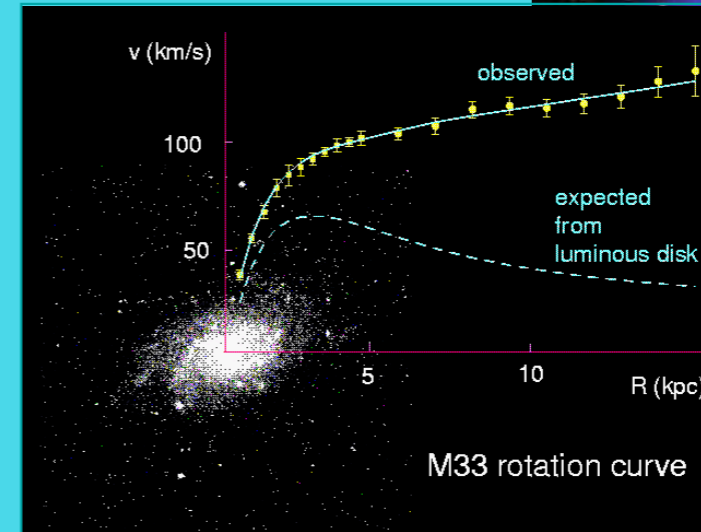
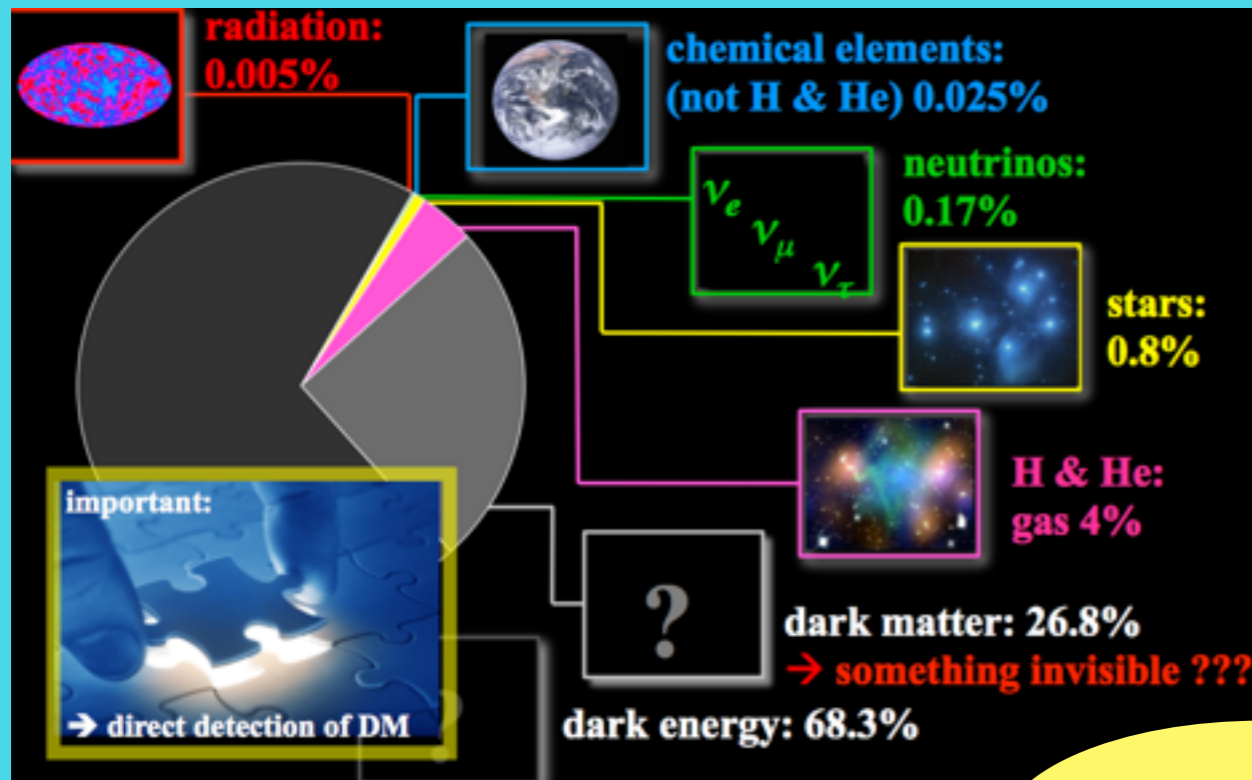
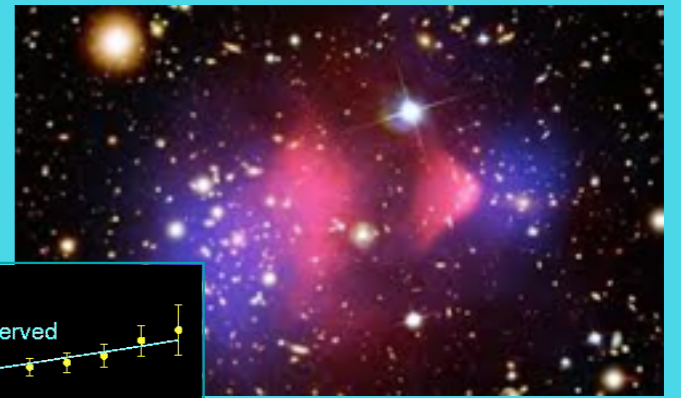

- rotation curves of stars
- gravitational lensing
- large scale structure of the Universe

The only candidate in the SM

Dark matter is made of:

Macro objects- not observed

New neutral particles

-
-
- right-handed neutrino
- neutralino
- sneutrino
- axion (axino)
- gravitino
- heavy photon
- light sterile Higgs

?

Dark Matter

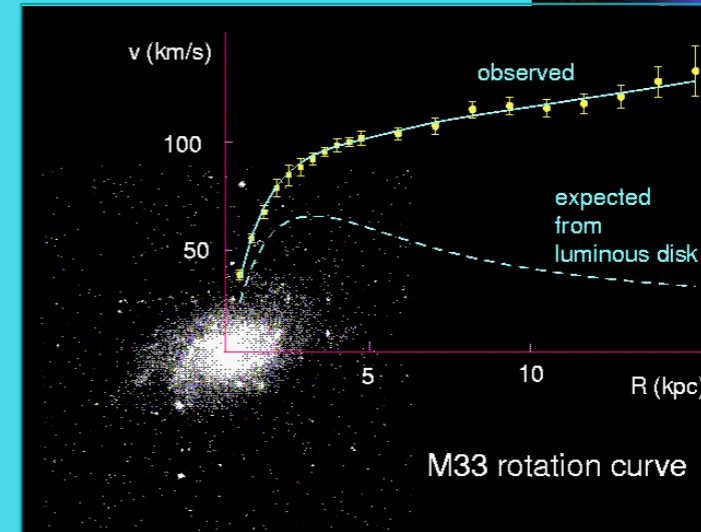
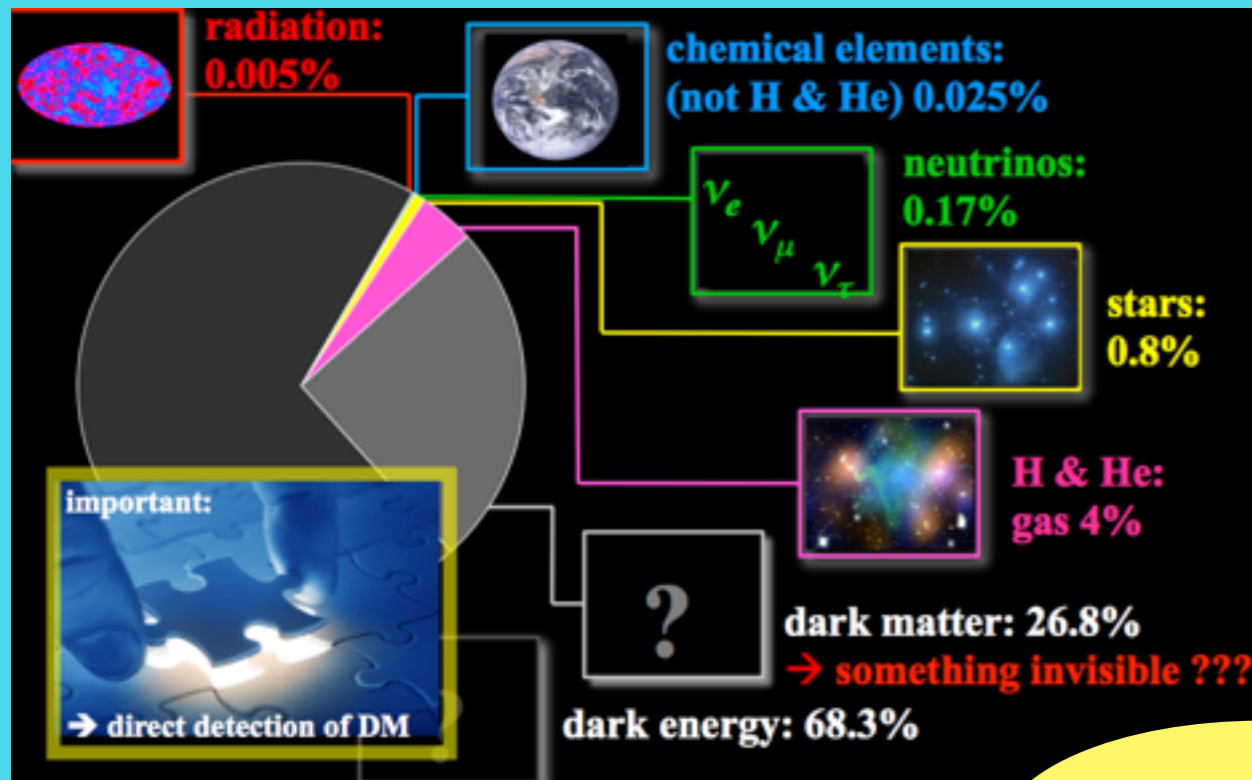
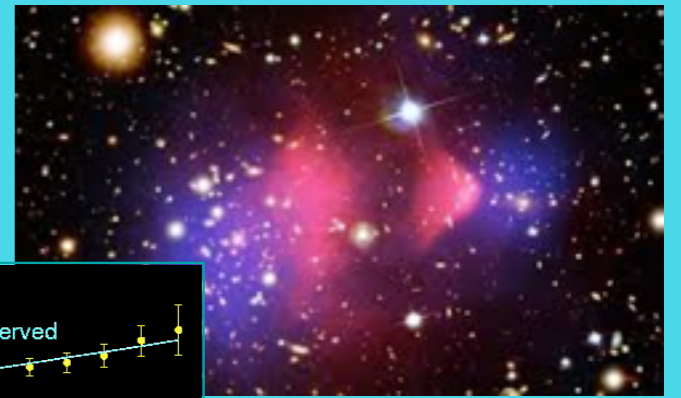

- rotation curves of stars
- gravitational lensing
- large scale structure of the Universe

The only candidate in the SM

Dark matter is made of:

- Macro objects- not observed
- New neutral particles

- right-handed neutrino
- neutralino
- sneutrino
- axion (axino)
- gravitino
- heavy photon
- light sterile Higgs

?

The main candidate in MSSM

Dark Matter

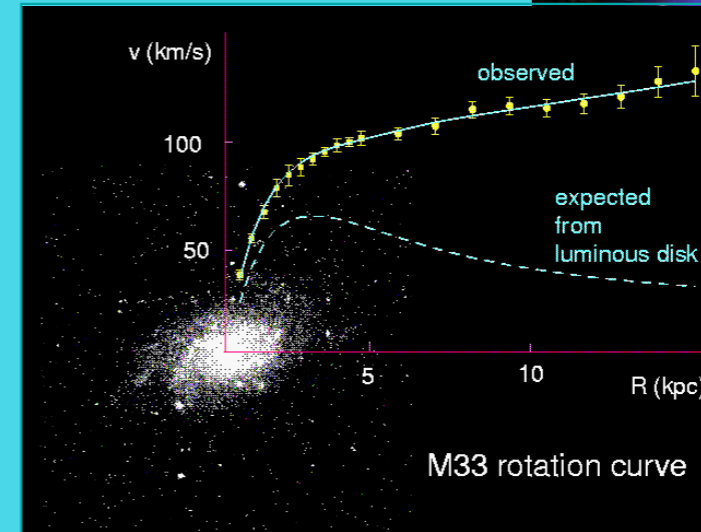
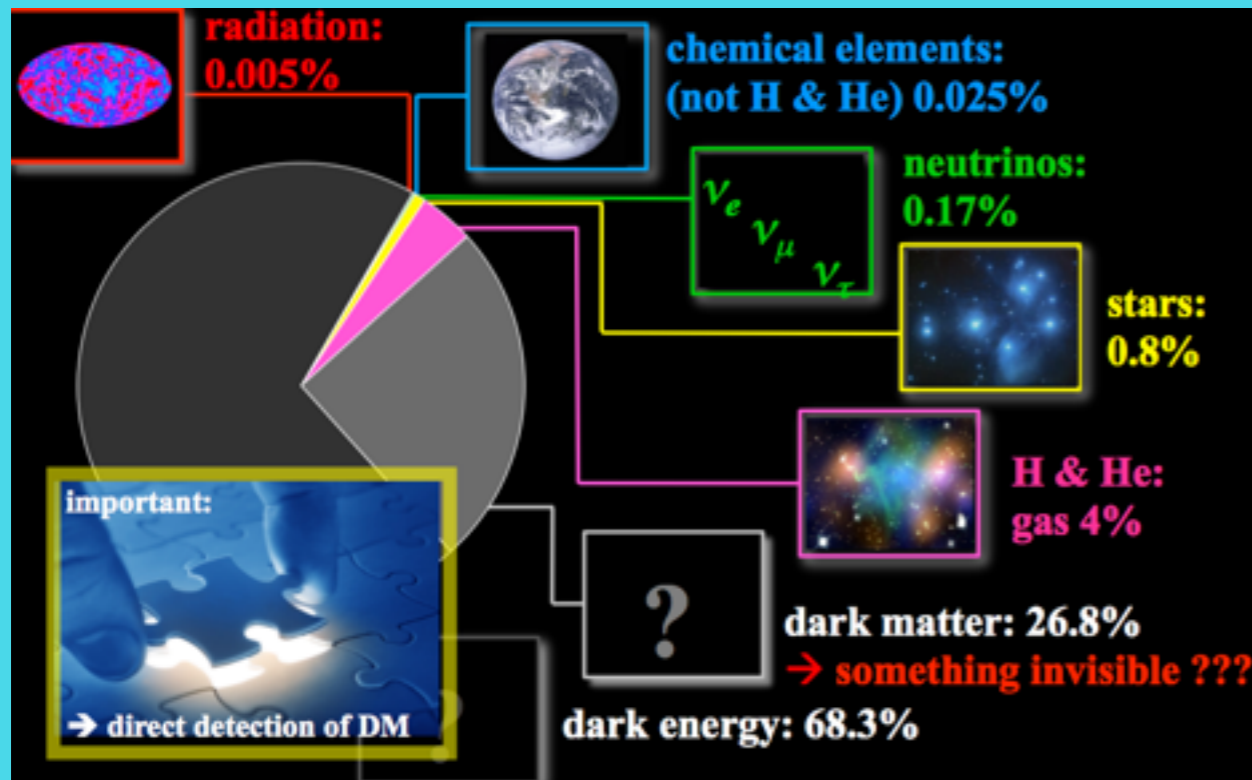
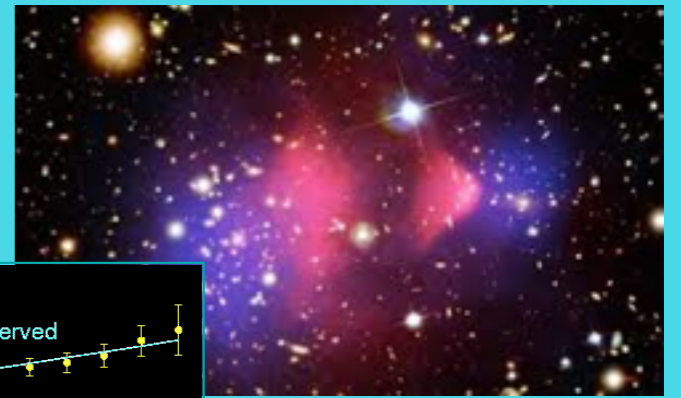

- rotation curves of stars
- gravitational lensing
- large scale structure of the Universe

Dark matter is made of:

- Macro objects- not observed
- New neutral particles

- right-handed neutrino
- neutralino
- sneutrino
- axion (axino)
- gravitino
- heavy photon
- light sterile Higgs

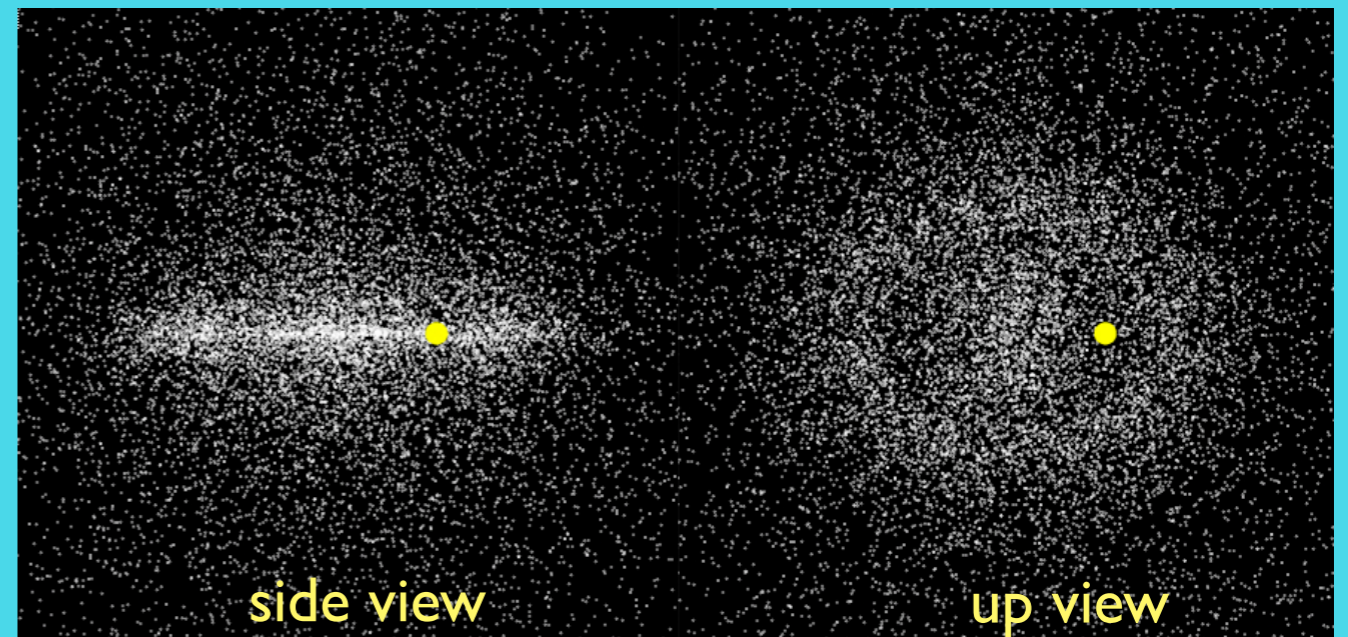

The structure of the DM halo in Milky Way

Dark Matter

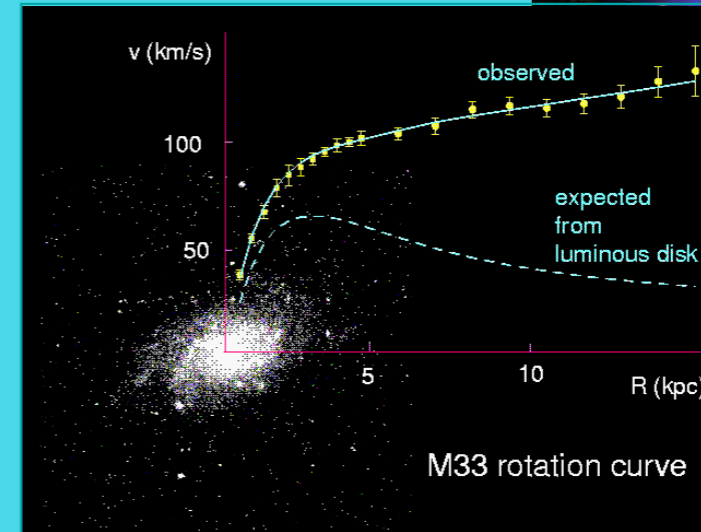
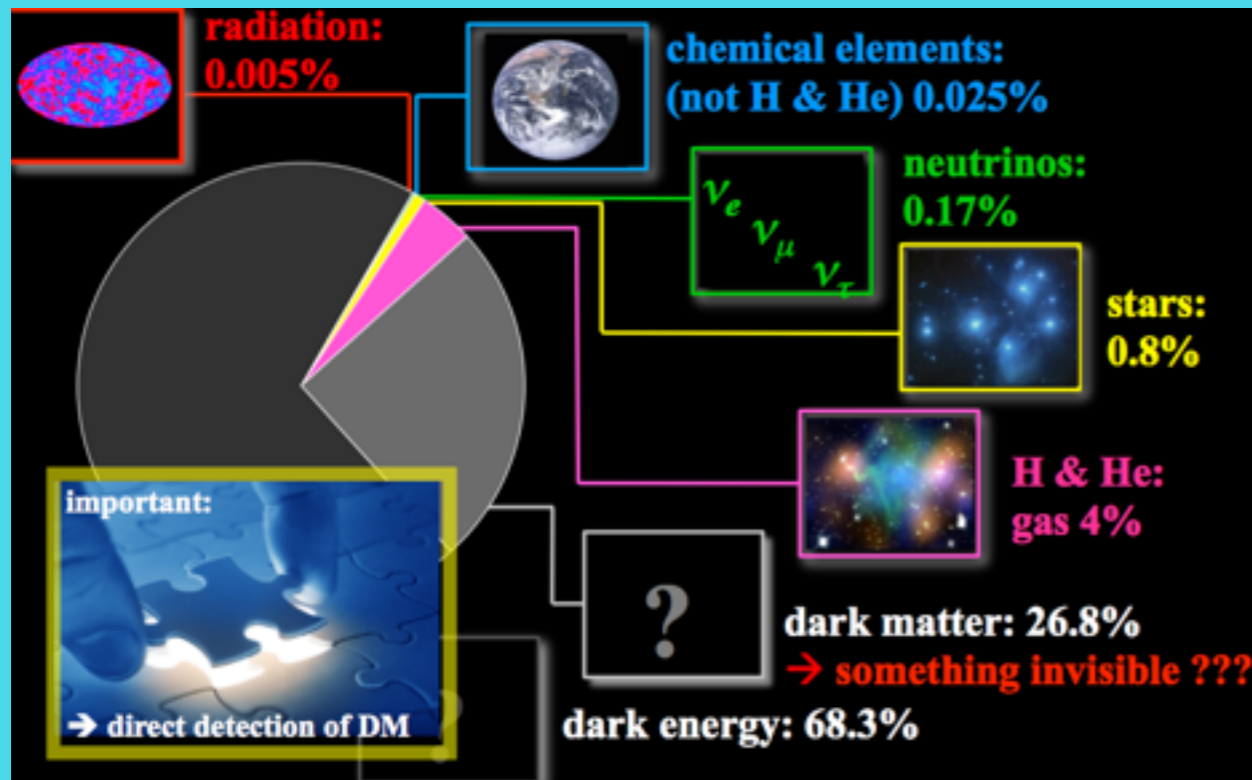
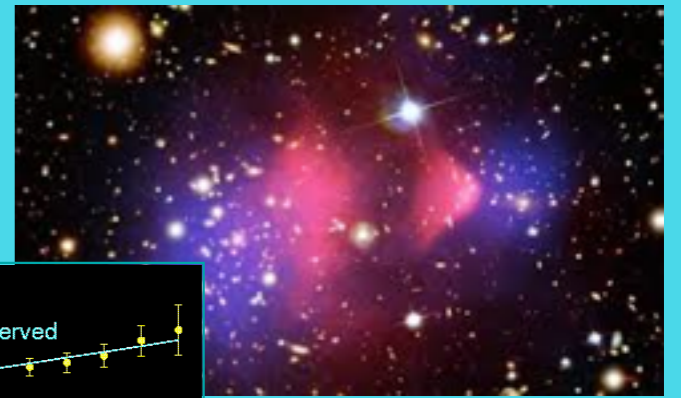

- rotation curves of stars
- gravitational lensing
- large scale structure of the Universe

Dark matter is made of:

- Macro objects- not observed
- New neutral particles

- right-handed neutrino
- neutralino
- sneutrino
- axion (axino)
- gravitino
- heavy photon
- light sterile Higgs

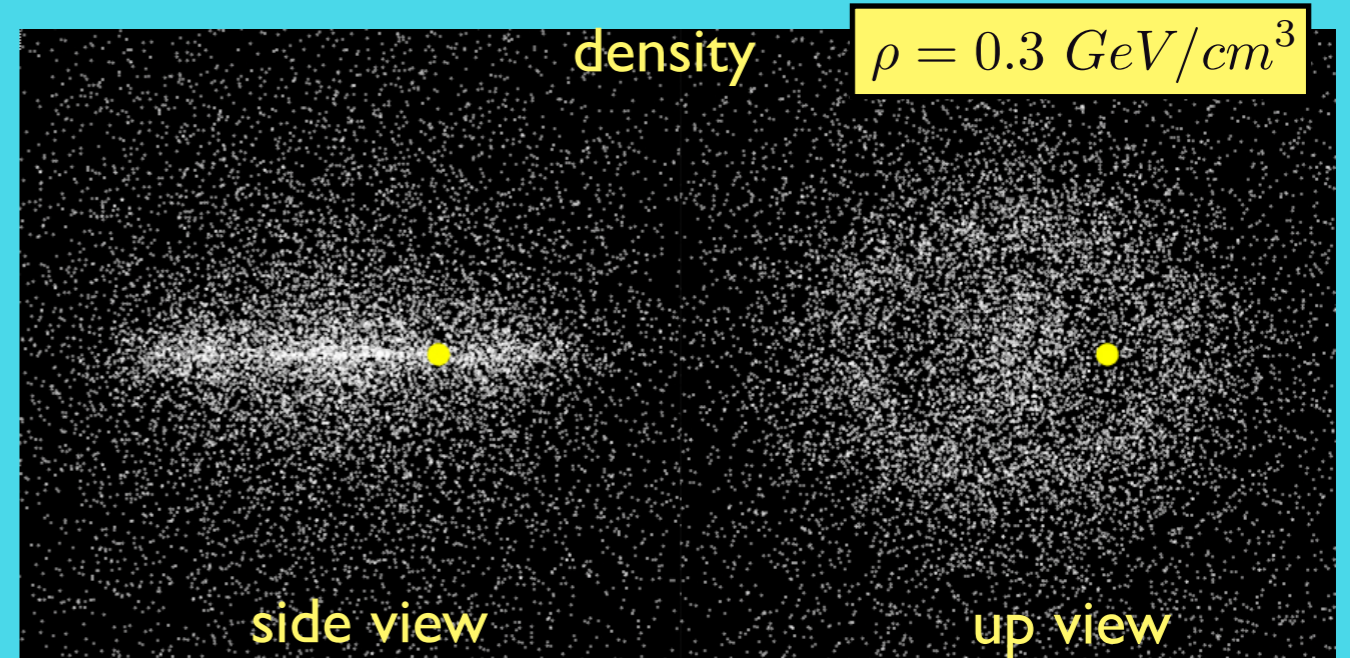

The structure of the DM halo in Milky Way

Search for the Dark Matter

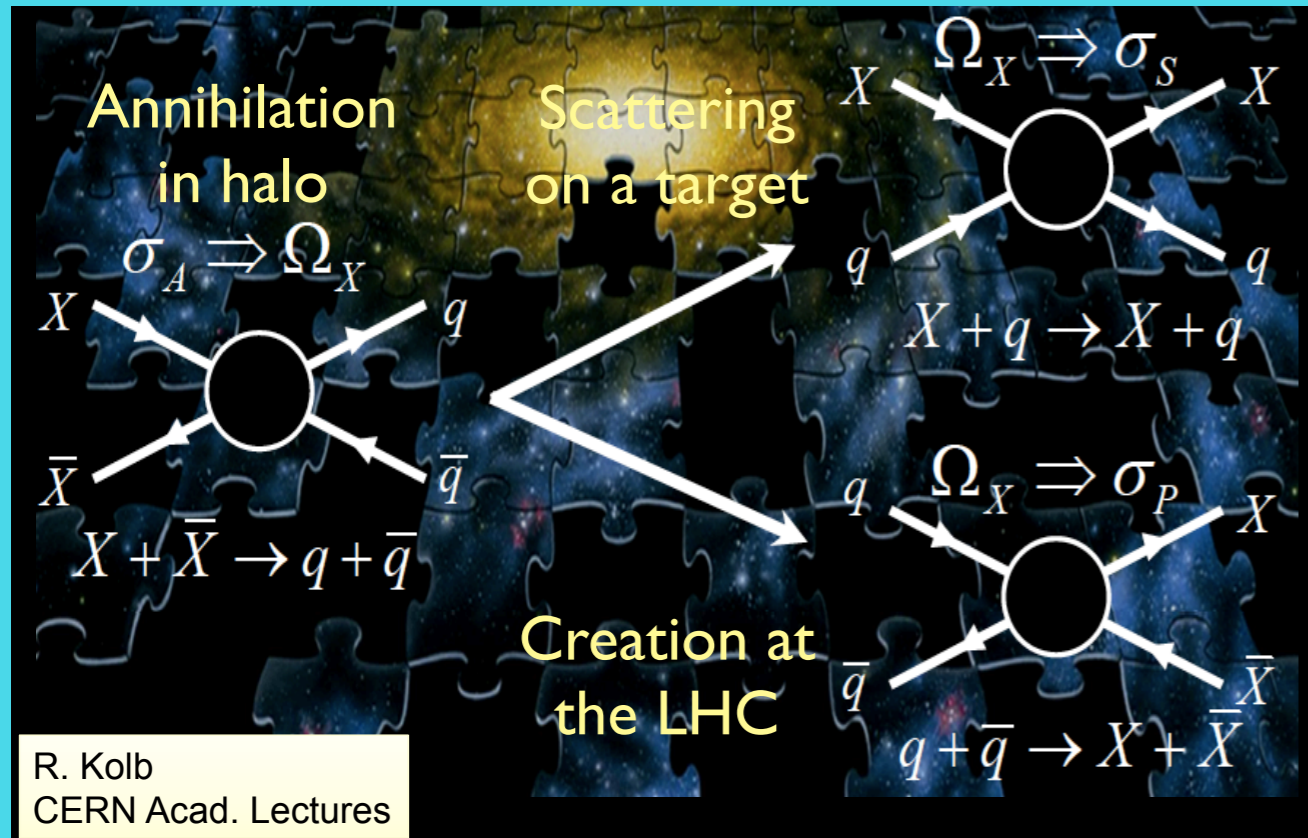

Search for the Dark Matter

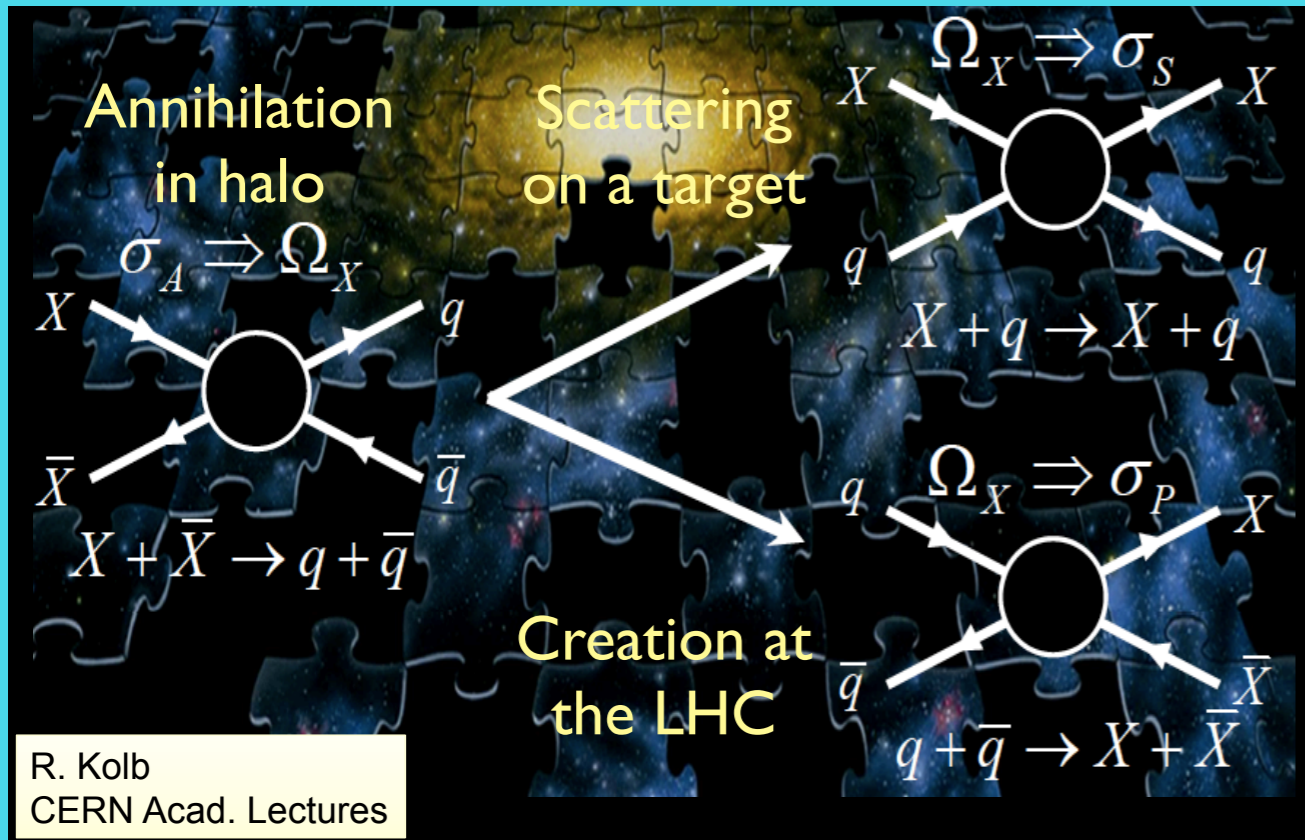

Annihilation
in halo

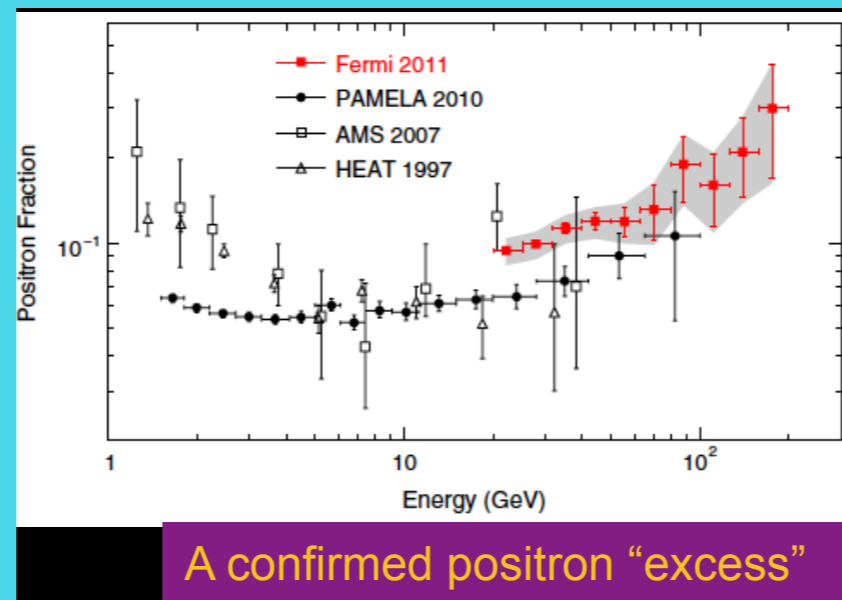
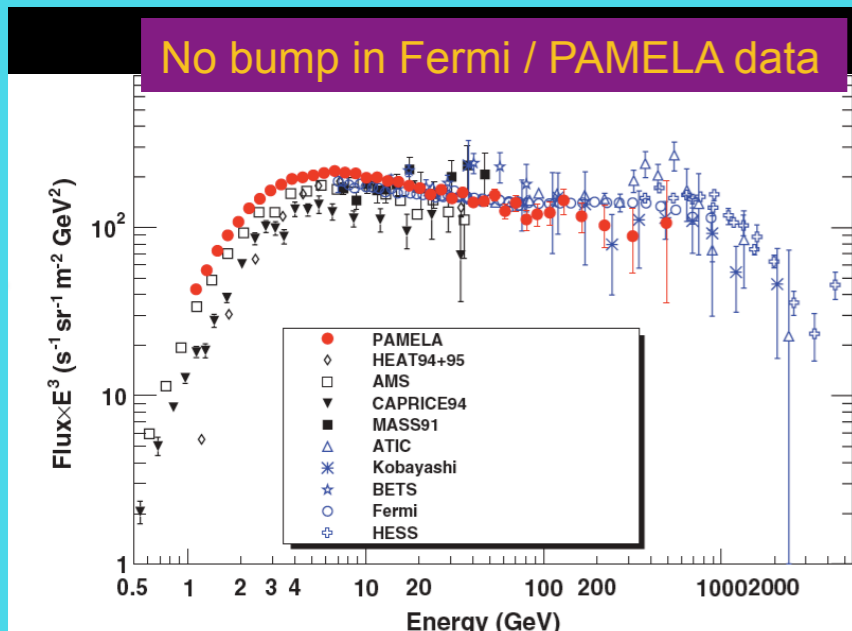

Search for the Dark Matter

Scattering
on a target

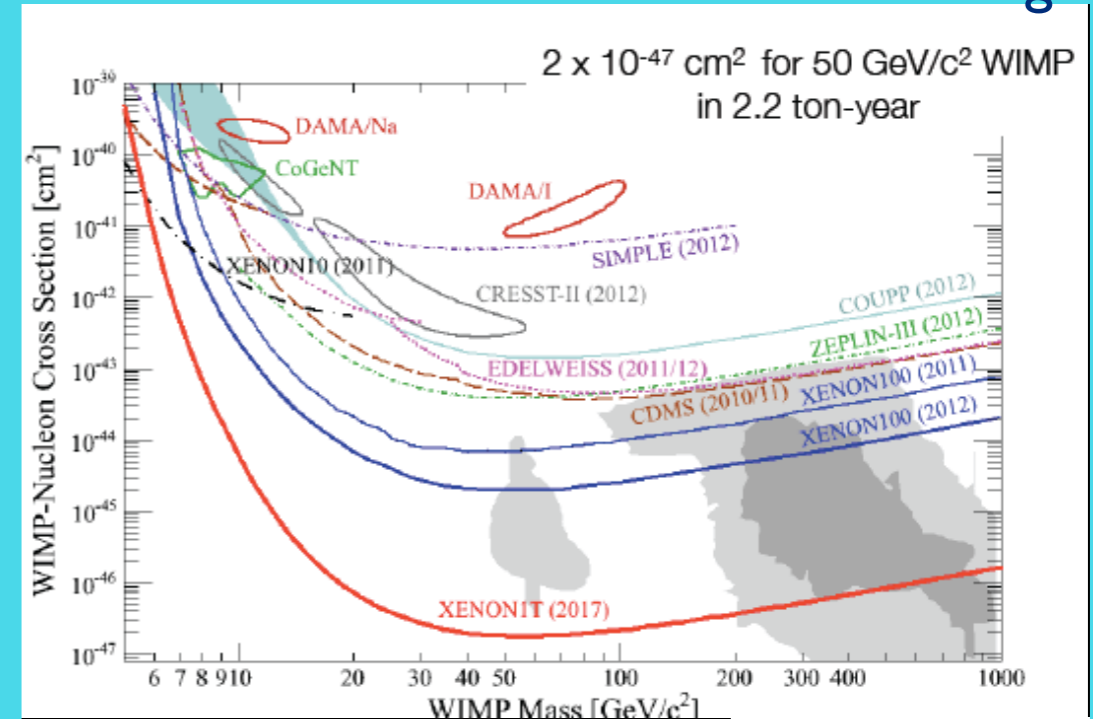
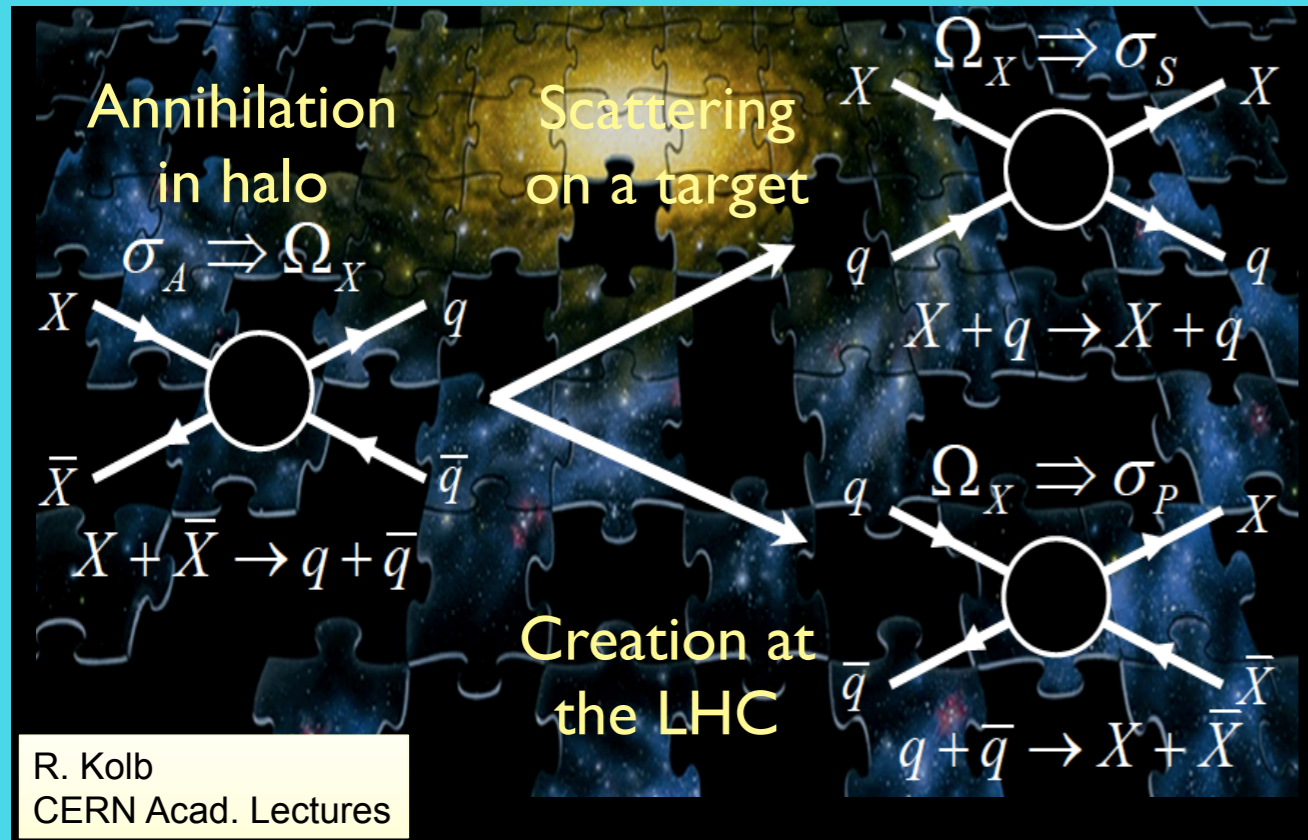

Annihilation
in halo

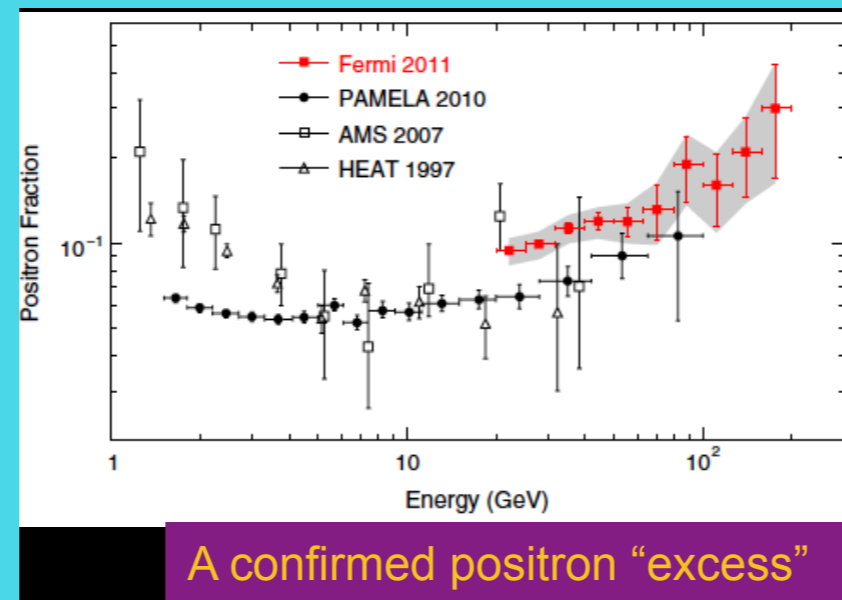
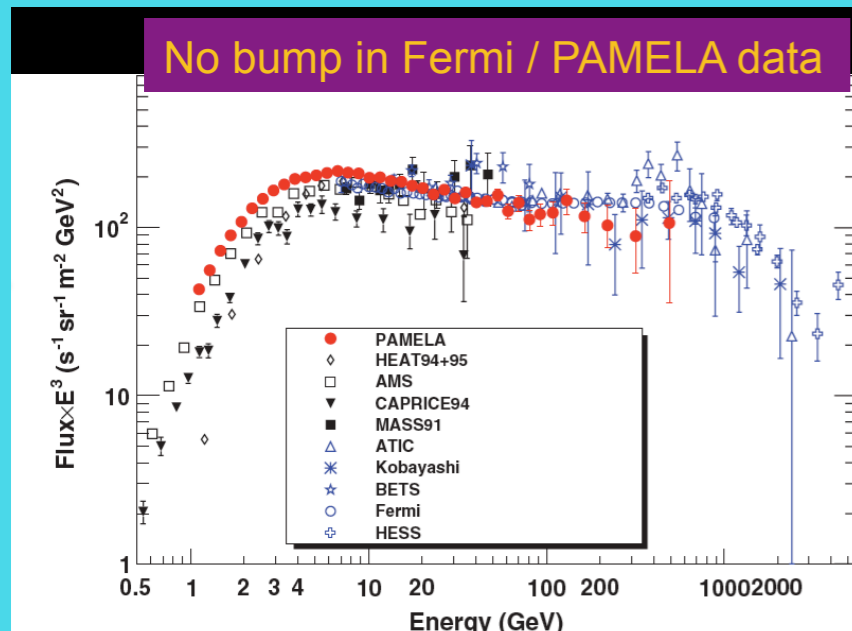

Search for the Dark Matter

Scattering
on a target

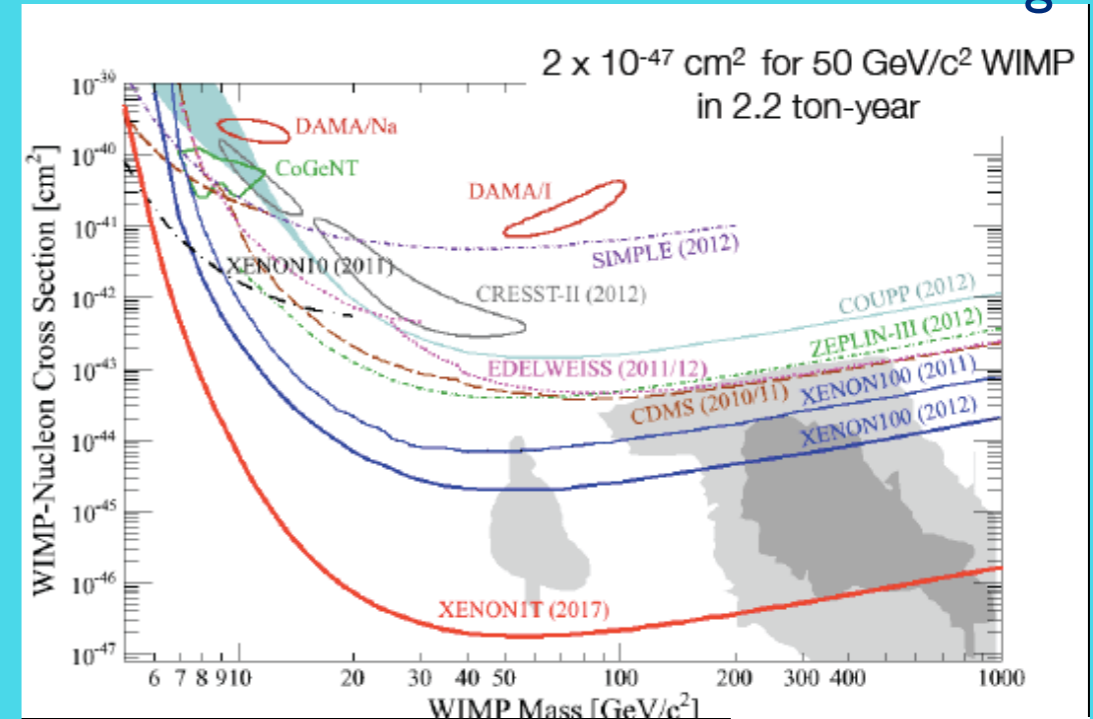
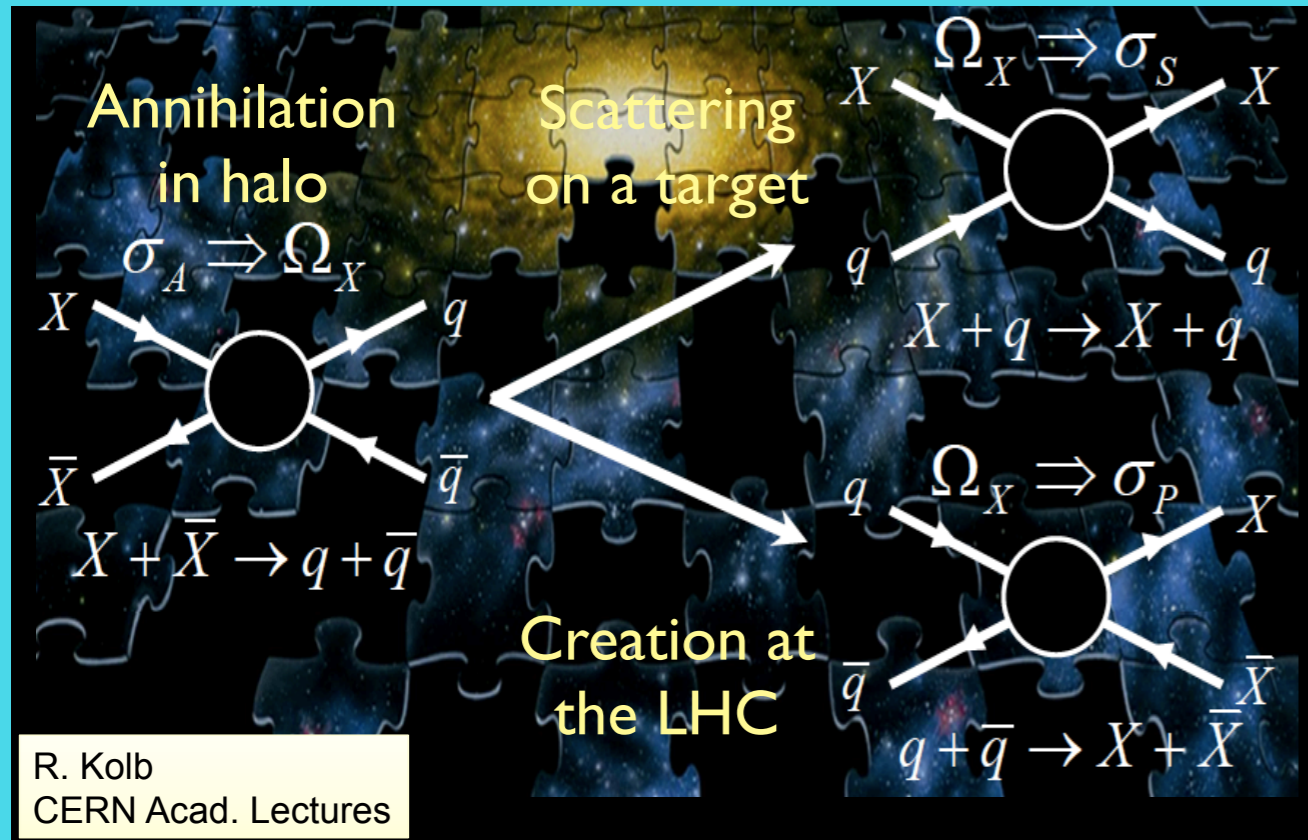

Annihilation
in halo

Creation at
the LHC

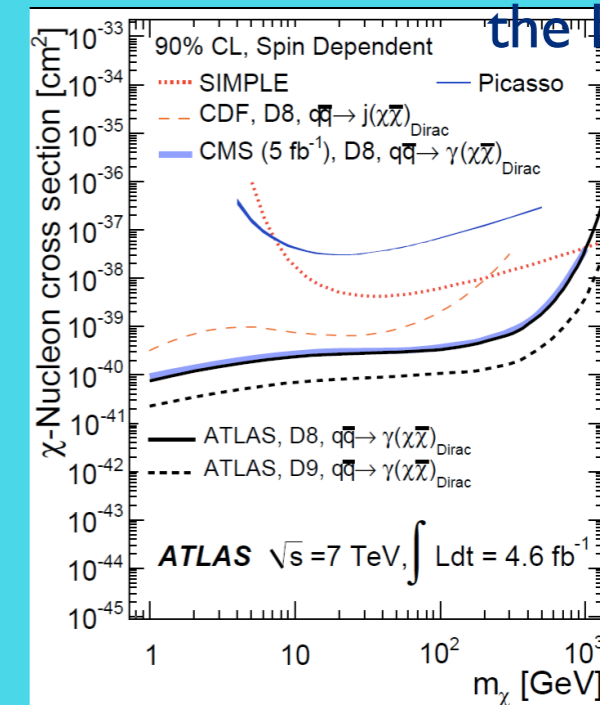
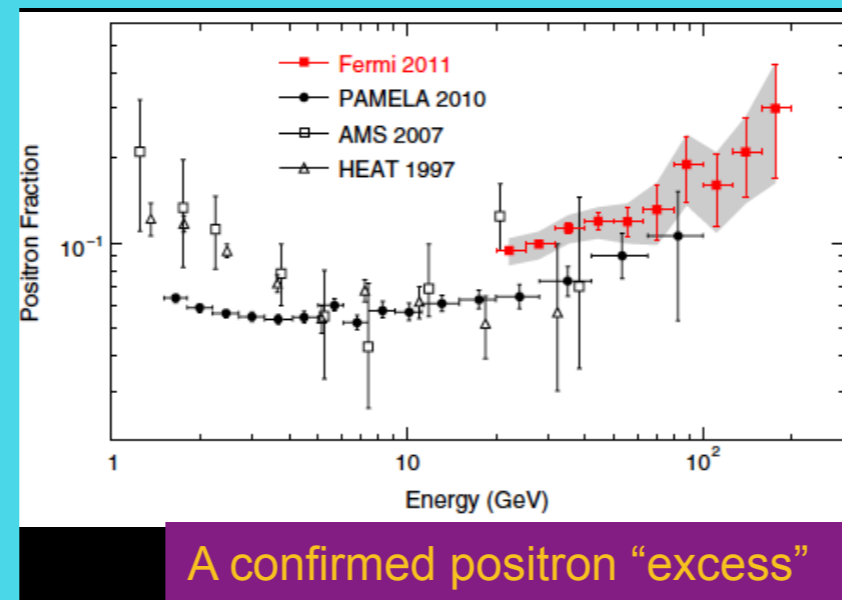
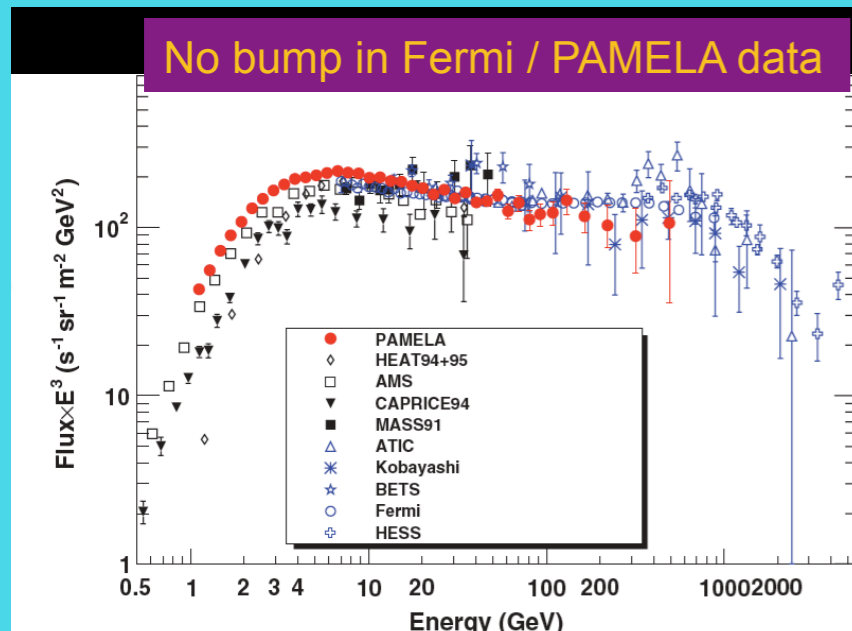

Search for the Dark Matter

Scattering
on a target

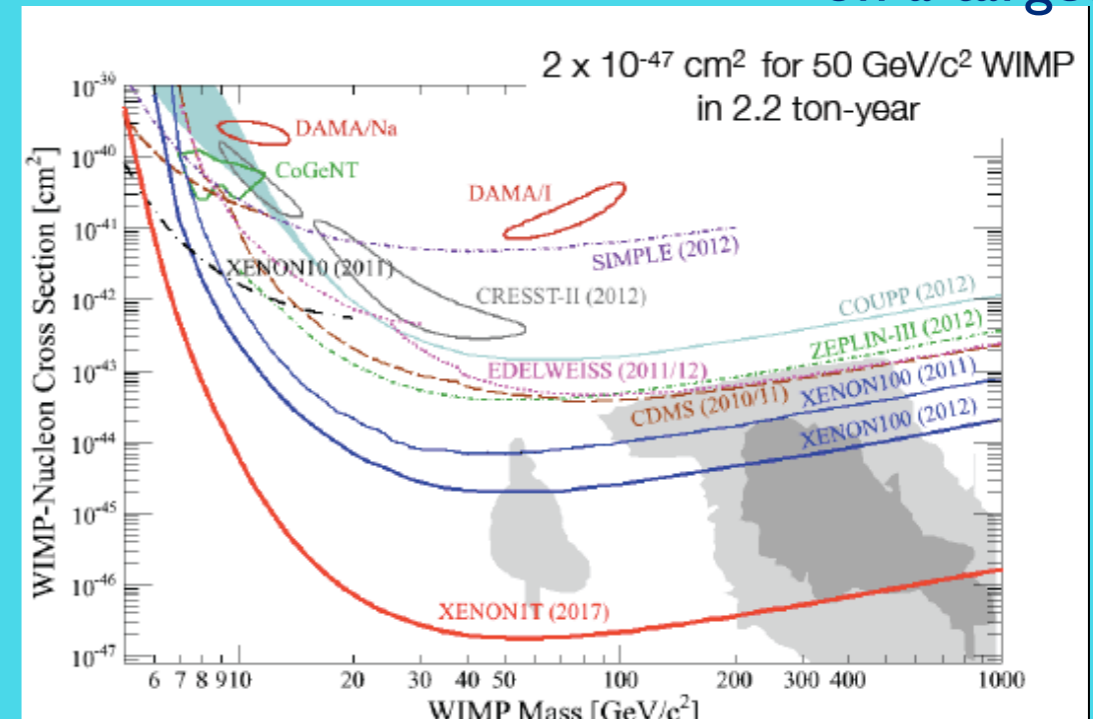
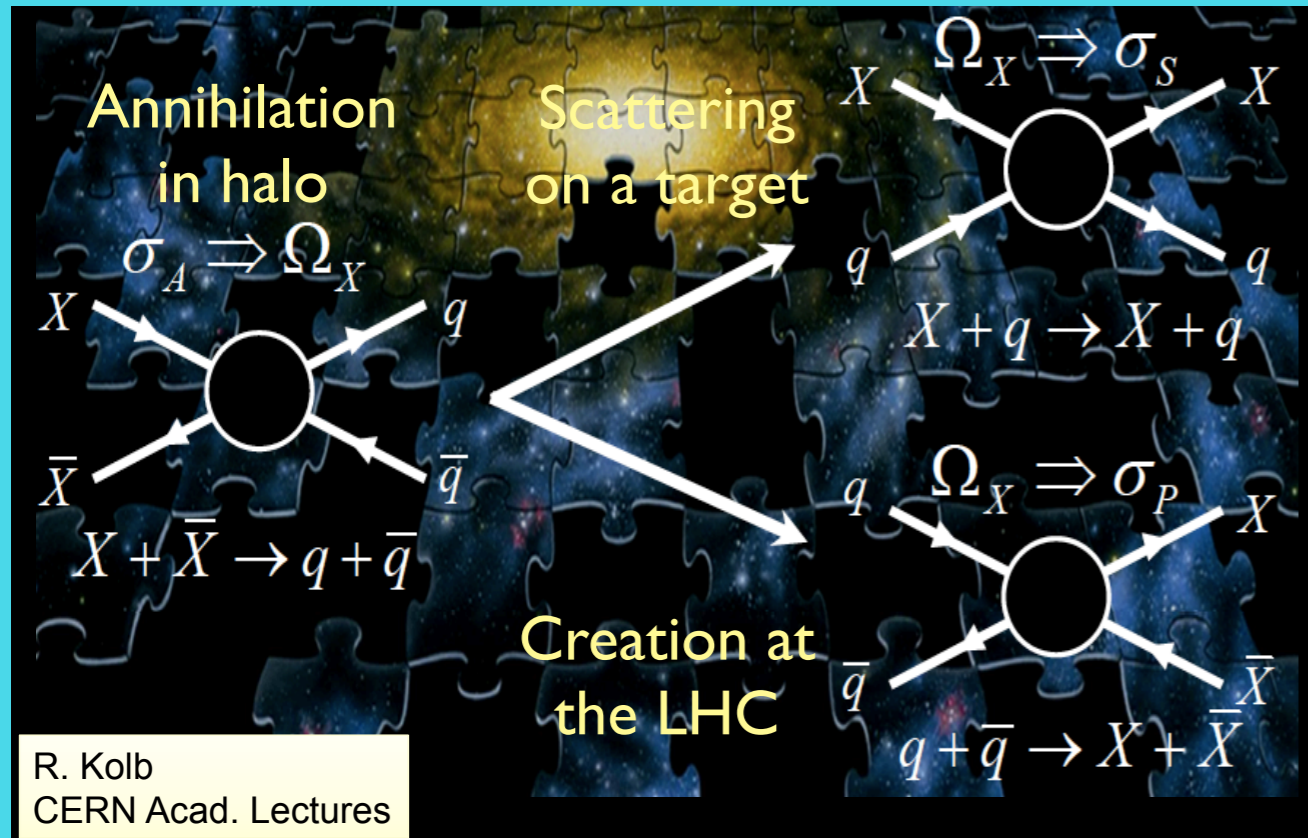

Annihilation
in halo

Creation at
the LHC

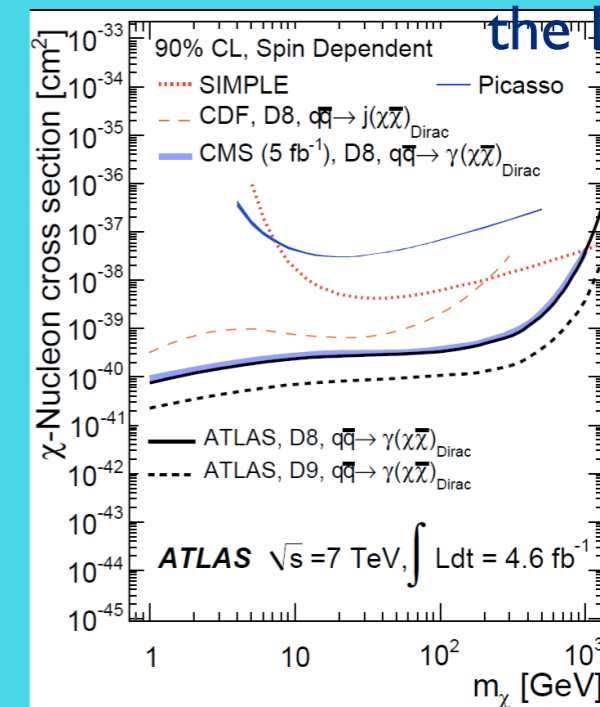
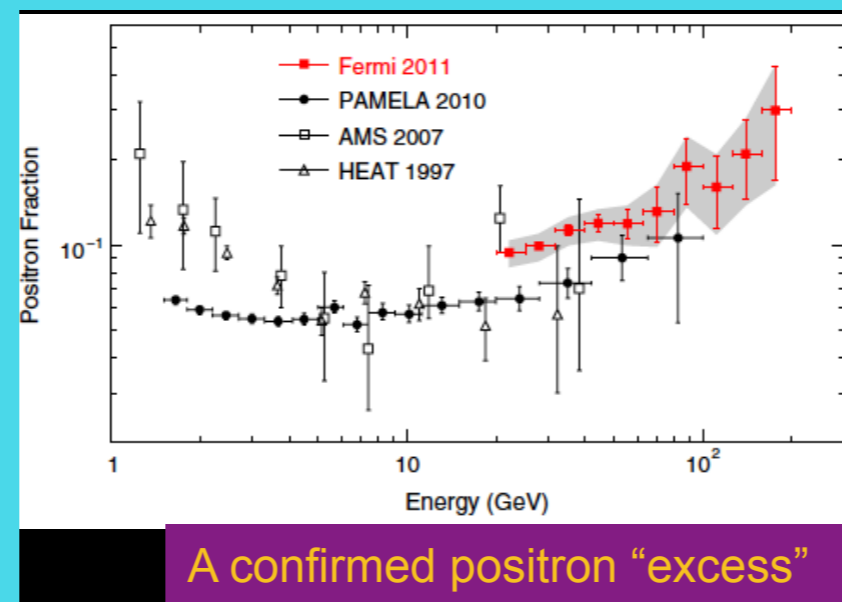
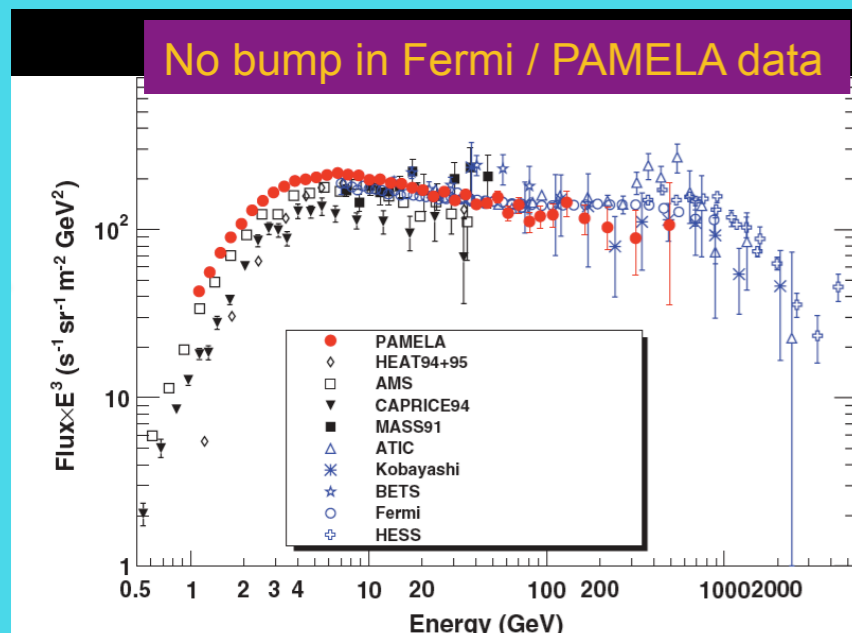

The signal is absent so far!

New Particles and Interactions

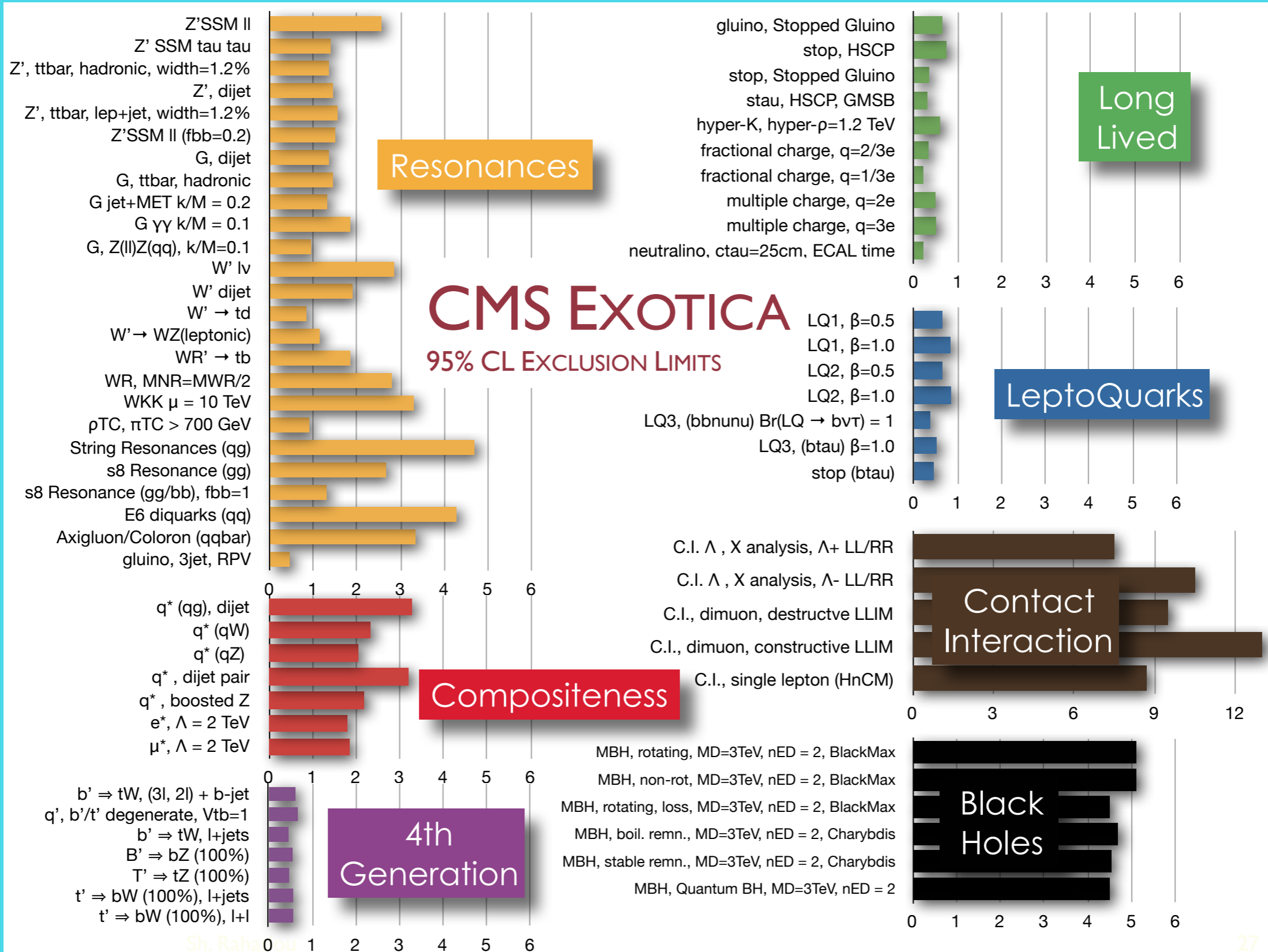

New Particles and Interactions

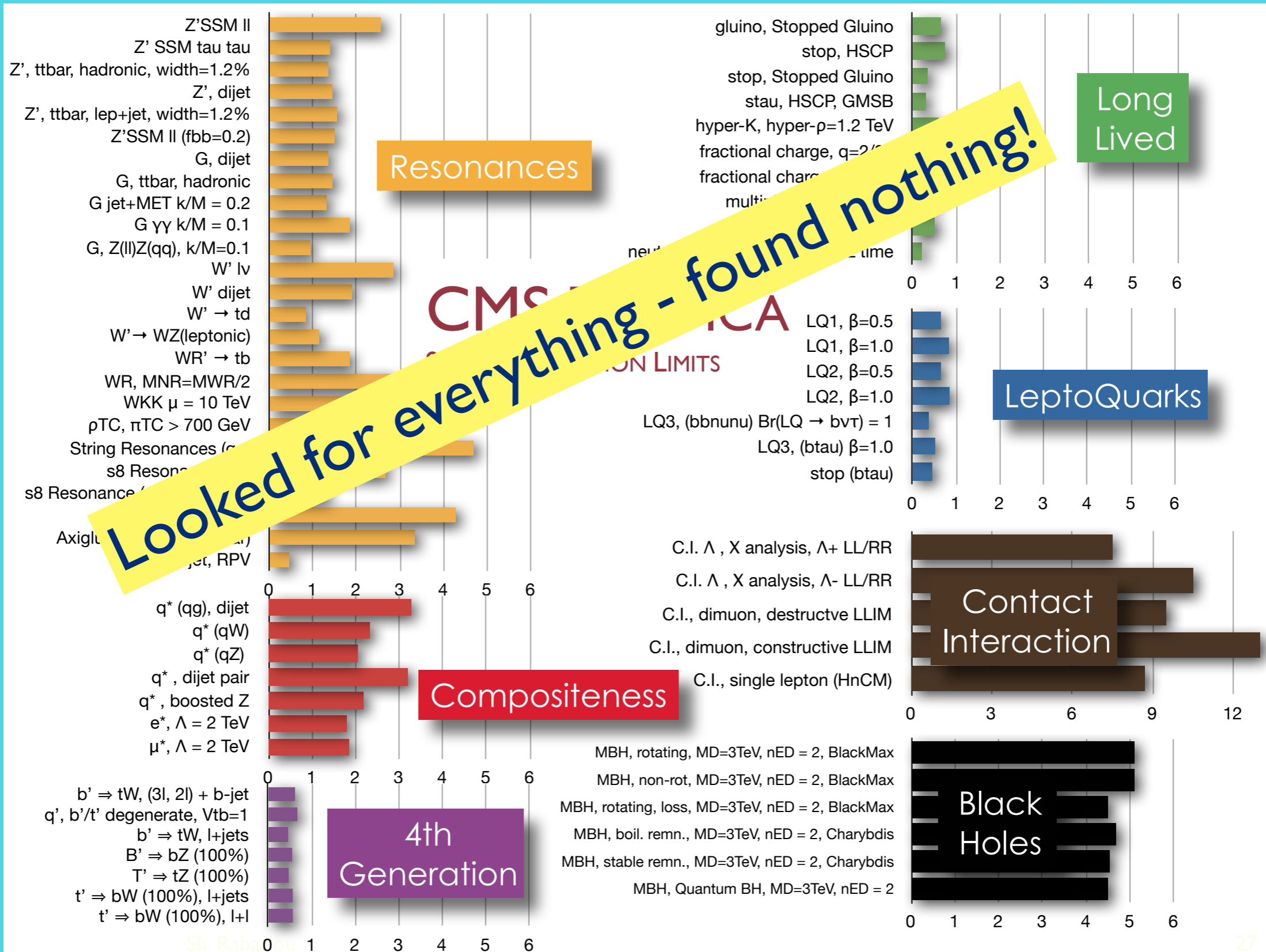

New Particles and Interactions

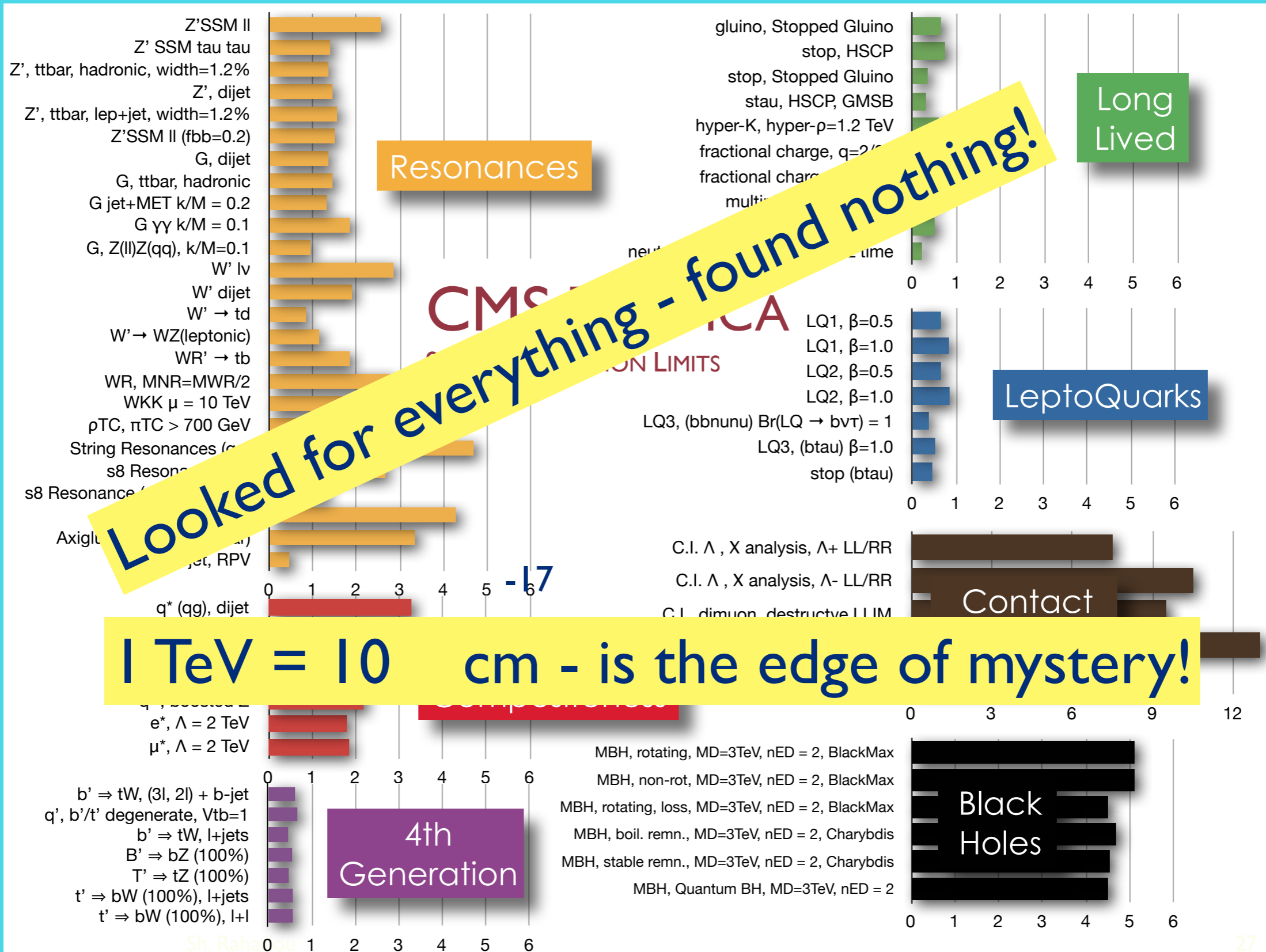

New Particles and Interactions

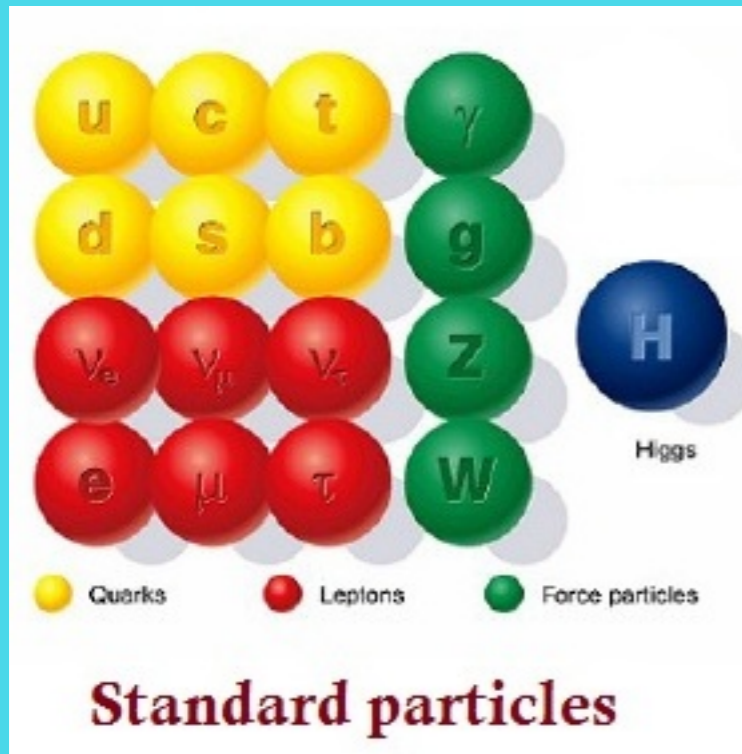

New Particles and Interactions

SUPERSYMMETRY

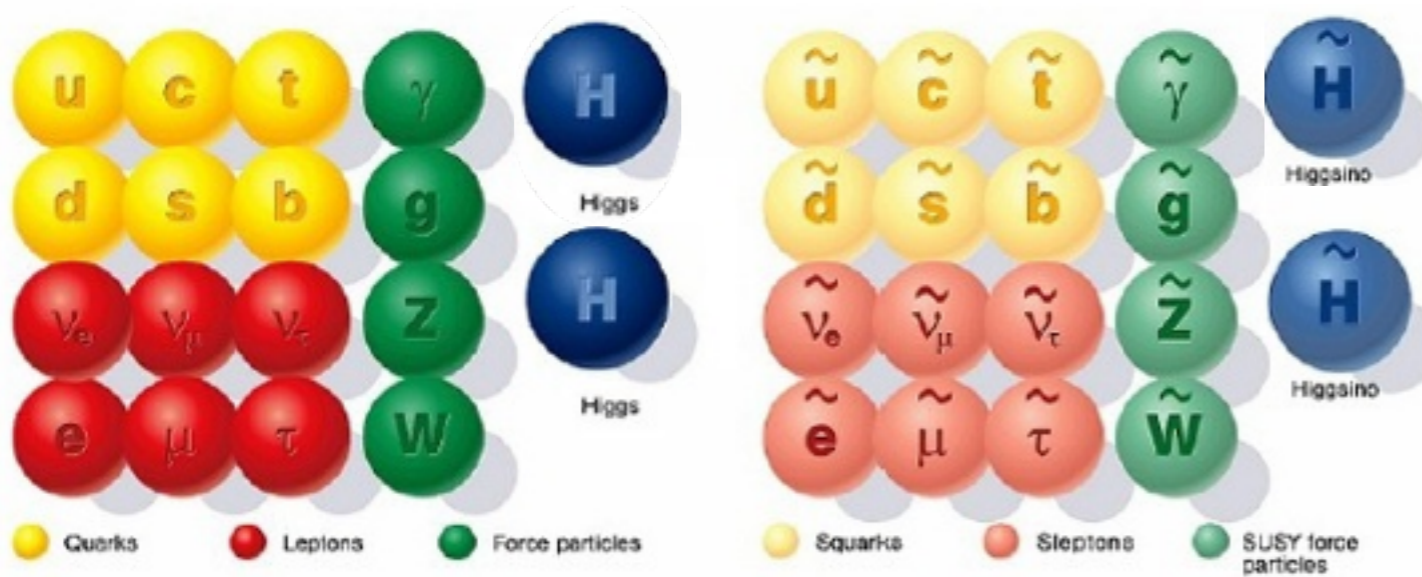

Standard particles

SUSY particles

New Particles and Interactions

Supersymmetry is a dream of a unified theory of all particles and interactions

SUPERSYMMETRY

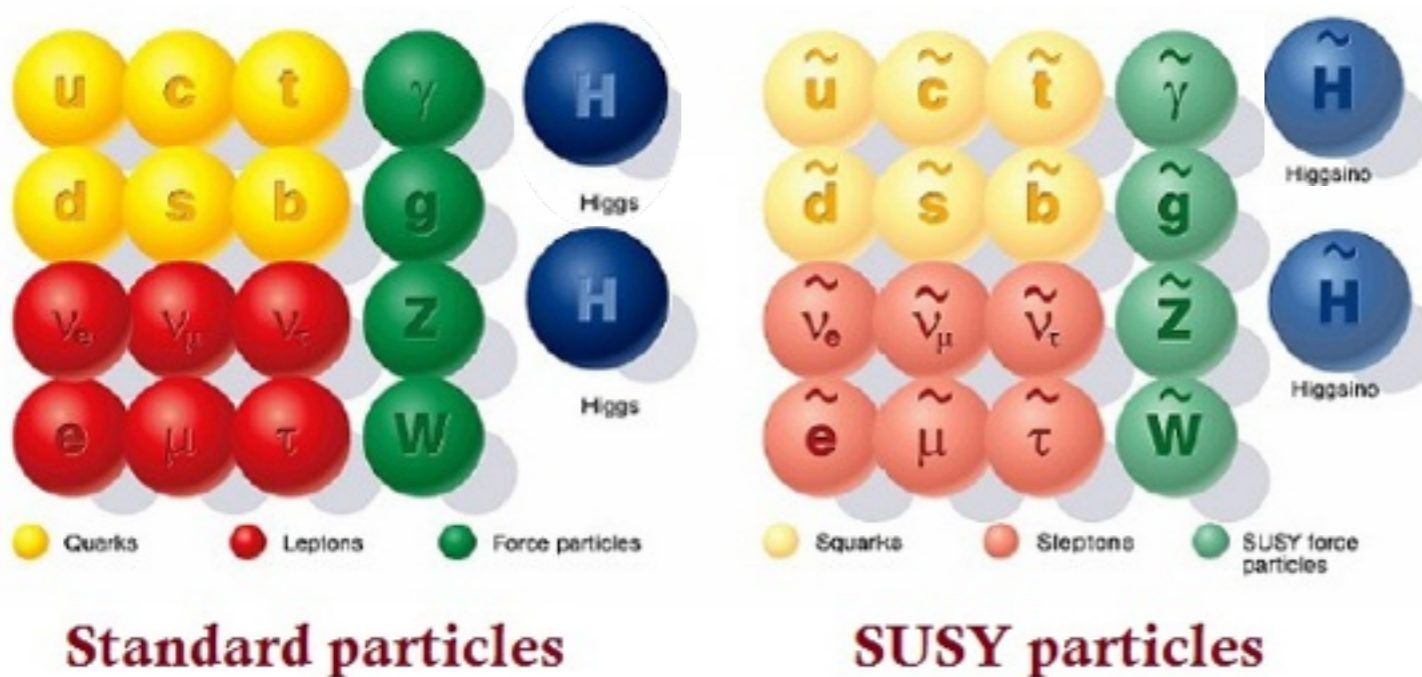

New Particles and Interactions

SUPERSYMMETRY

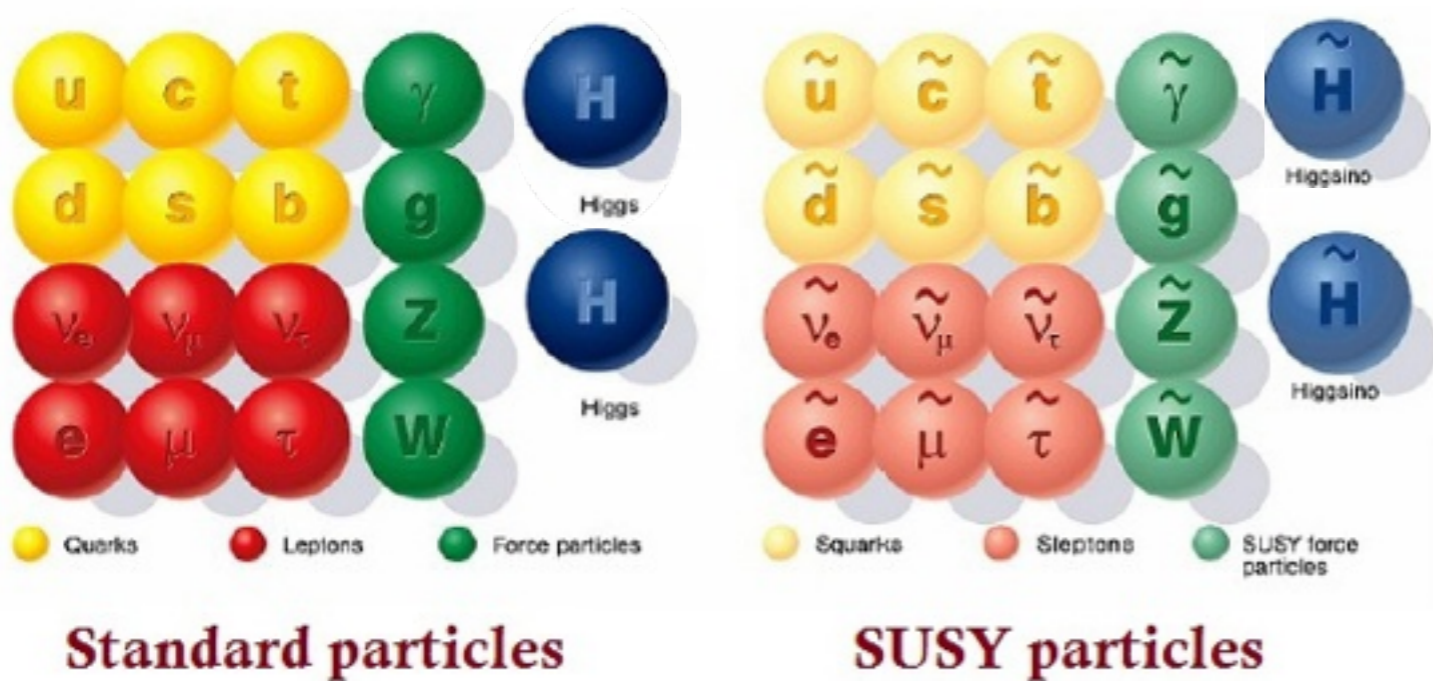

Supersymmetry is a dream of a unified theory of all particles and interactions

	Дальнодействующее (с безмассовым бозоном)	Короткодействующее (с массивными бозонами)	"Конфайнментовое"
Спин 0 (скалярные поля)		Хиггсовское $V(r) \sim \frac{A}{r} e^{-Br}$	
Спин 1 (векторные поля)	Электромагнитное $V(r) \sim \frac{A}{r}$	Слабое $V(r) \sim \frac{A}{r} e^{-Br}$	Сильное $V(r) \sim \frac{A}{r} + Cr$
Спин 2 (тензорные поля)	Гравитационное $V(r) \sim \frac{A}{r}$		

New Particles and Interactions

SUPERSYMMETRY

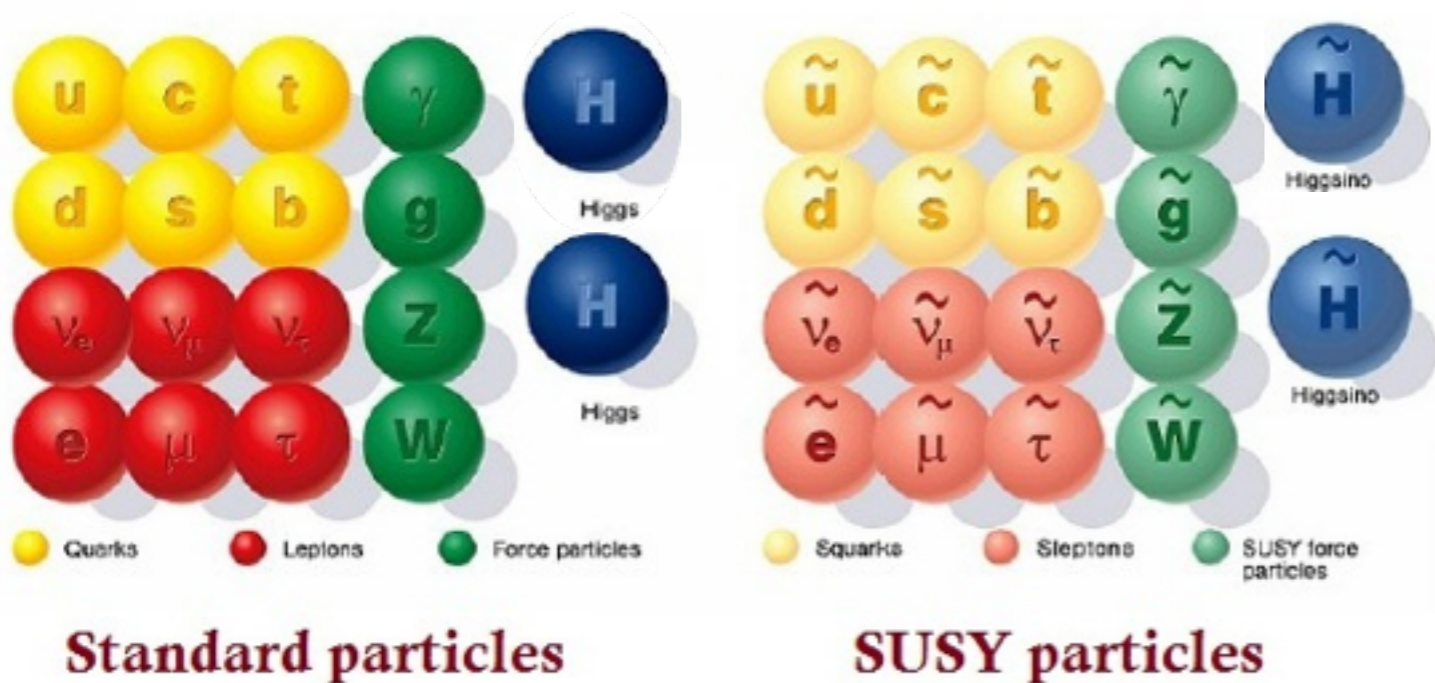

Supersymmetry is a dream of a unified theory of all particles and interactions

	Дальнодействующее (с безмассовым бозоном)	Короткодействующее (с массивными бозонами)	"Конфайнментовое"
Спин 0 (скалярные поля)		Хиггсовское $V(r) \sim \frac{A}{r} e^{-Br}$	
Спин 1 (векторные поля)	Электромагнитное $V(r) \sim \frac{A}{r}$	Слабое $V(r) \sim \frac{A}{r} e^{-Br}$	Сильное $V(r) \sim \frac{A}{r} + Cr$
Спин 2 (тензорные поля)	Гравитационное $V(r) \sim \frac{A}{r}$		

Why SUSY?

New Particles and Interactions

SUPERSYMMETRY

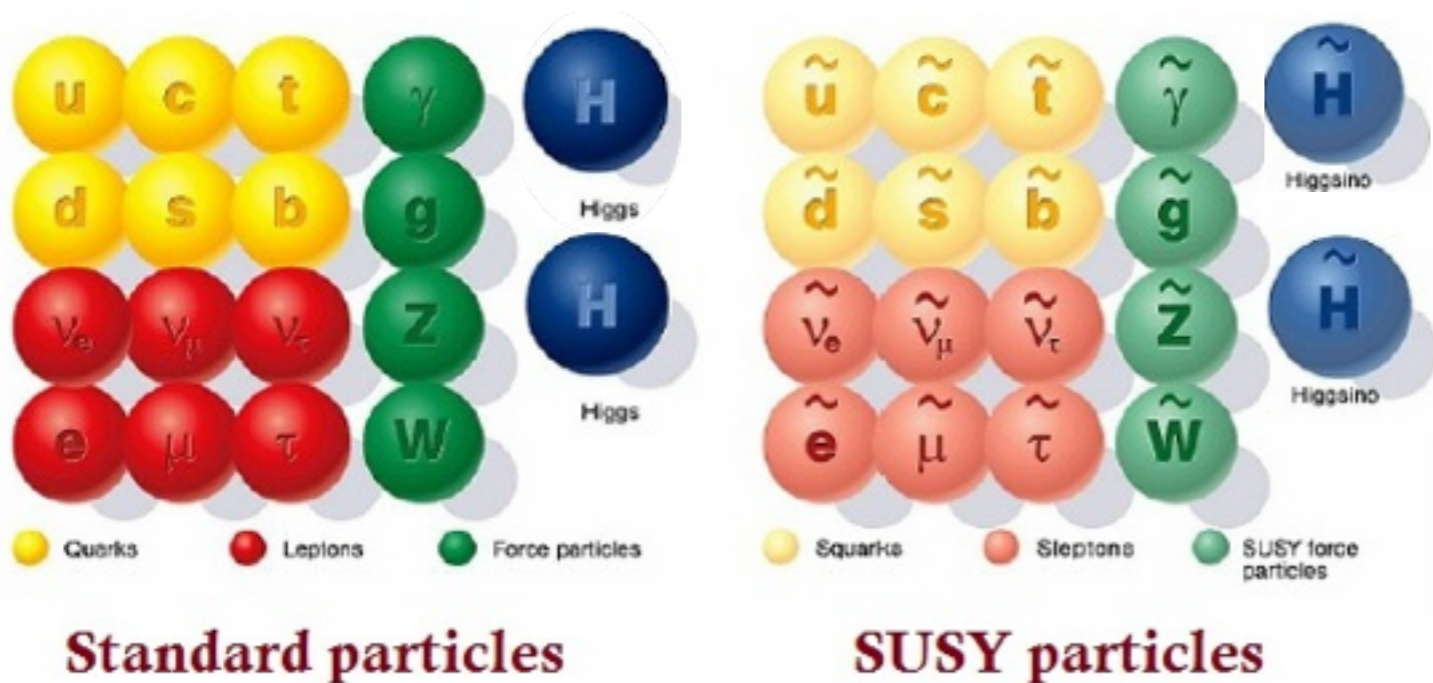

Supersymmetry is a dream of a unified theory of all particles and interactions

	Дальнодействующее (с безмассовым бозоном)	Короткодействующее (с массивными бозонами)	"Конфайнментовое"
Спин 0 (скалярные поля)		Хиггсовское $V(r) \sim \frac{A}{r} e^{-Br}$	
Спин 1 (векторные поля)	Электромагнитное $V(r) \sim \frac{A}{r}$	Слабое $V(r) \sim \frac{A}{r} e^{-Br}$	Сильное $V(r) \sim \frac{A}{r} + Cr$
Спин 2 (тензорные поля)	Гравитационное $V(r) \sim \frac{A}{r}$		

Why SUSY?

📌 Unification of the gauge couplings

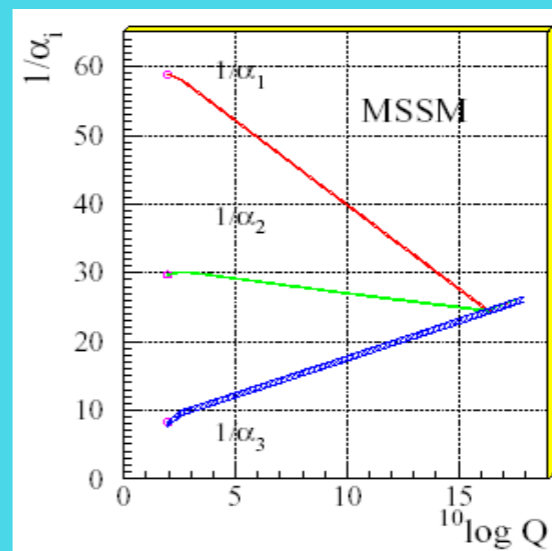

The basis of a grand Unified Theory

New Particles and Interactions

SUPERSYMMETRY

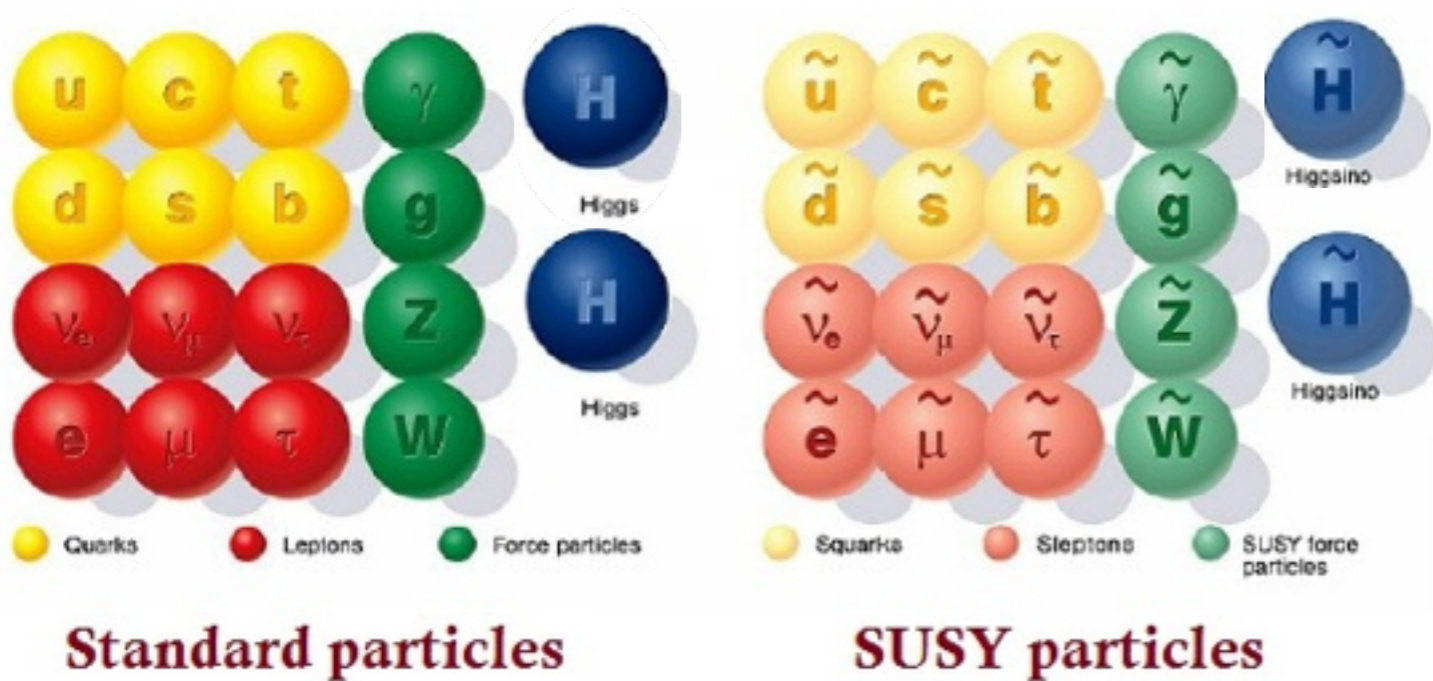

Supersymmetry is a dream of a unified theory of all particles and interactions

	Дальнодействующее (с безмассовым бозоном)	Короткодействующее (с массивными бозонами)	"Конфайнментовое"
Спин 0 (скалярные поля)		Хиггсовское $V(r) \sim \frac{A}{r} e^{-Br}$	
Спин 1 (векторные поля)	Электромагнитное $V(r) \sim \frac{A}{r}$	Слабое $V(r) \sim \frac{A}{r} e^{-Br}$	Сильное $V(r) \sim \frac{A}{r} + Cr$
Спин 2 (тензорные поля)	Гравитационное $V(r) \sim \frac{A}{r}$		

Why SUSY?

- Unification of the gauge couplings
- Solution of the hierarchy problem

Cancellations of corrections and stabilization of the Higgs potential

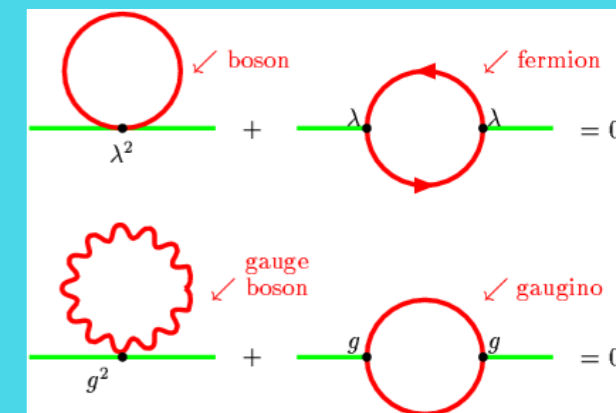

New Particles and Interactions

SUPERSYMMETRY

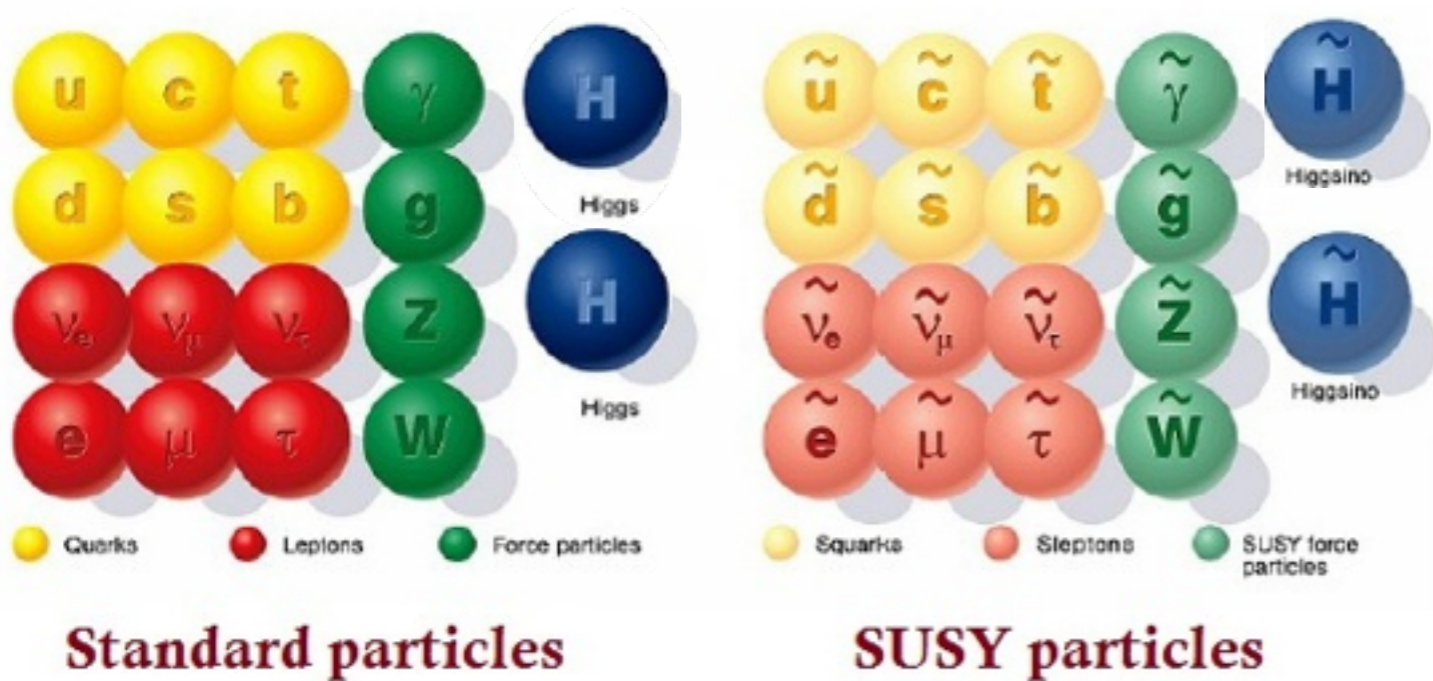

Supersymmetry is a dream of a unified theory of all particles and interactions

	Дальнодействующее (с безмассовым бозоном)	Короткодействующее (с массивными бозонами)	"Конфайнментовое"
Спин 0 (скалярные поля)		Хиггсовское $V(r) \sim \frac{A}{r} e^{-Br}$	
Спин 1 (векторные поля)	Электромагнитное $V(r) \sim \frac{A}{r}$	Слабое $V(r) \sim \frac{A}{r} e^{-Br}$	Сильное $V(r) \sim \frac{A}{r} + Cr$
Спин 2 (тензорные поля)	Гравитационное $V(r) \sim \frac{A}{r}$		

Why SUSY?

- Unification of the gauge couplings
- Solution of the hierarchy problem
- Explanation of the EW symmetry violation

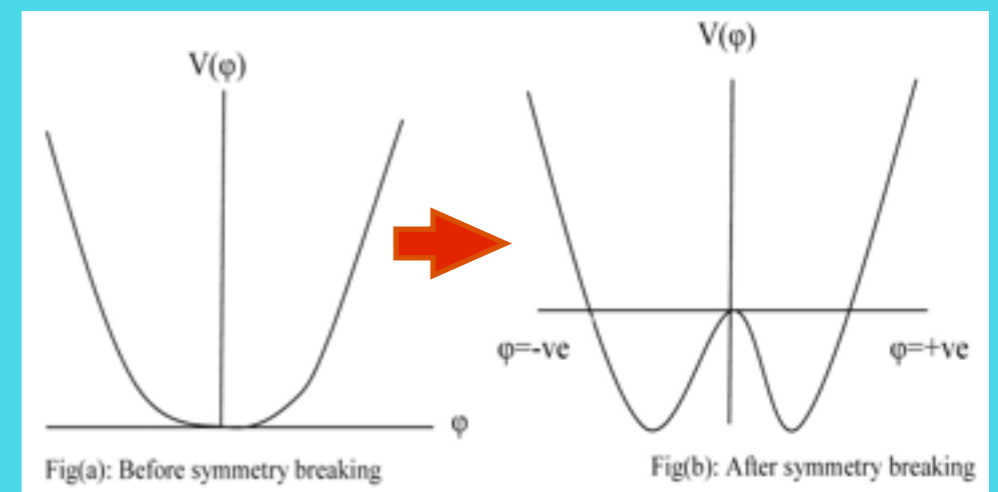

Violation of symmetry comes from radiative corrections

New Particles and Interactions

SUPERSYMMETRY

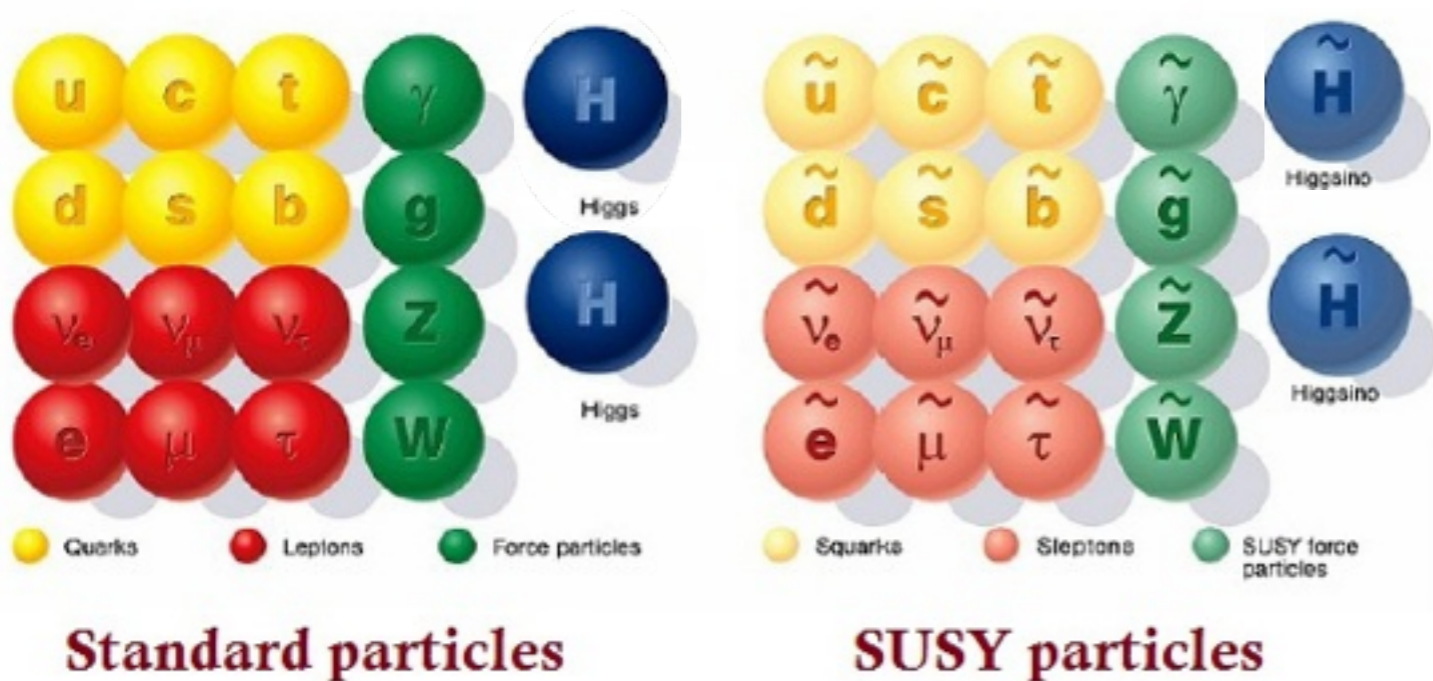

Supersymmetry is a dream of a unified theory of all particles and interactions

	Дальнодействующее (с безмассовым бозоном)	Короткодействующее (с массивными бозонами)	"Конфайнментовое"
Спин 0 (скалярные поля)		Хиггсовское $V(r) \sim \frac{A}{r} e^{-Br}$	
Спин 1 (векторные поля)	Электромагнитное $V(r) \sim \frac{A}{r}$	Слабое $V(r) \sim \frac{A}{r} e^{-Br}$	Сильное $V(r) \sim \frac{A}{r} + Cr$
Спин 2 (тензорные поля)	Гравитационное $V(r) \sim \frac{A}{r}$		

Why SUSY?

- Unification of the gauge couplings
- Solution of the hierarchy problem
- Explanation of the EW symmetry violation
- Provided the DM particle

$$\tilde{\chi}^0 = N_1 \tilde{\gamma} + N_2 \tilde{z} + N_3 \tilde{H}_1^0 + N_4 \tilde{H}_2^0$$

Neutralino

New Particles and Interactions

SUPERSYMMETRY

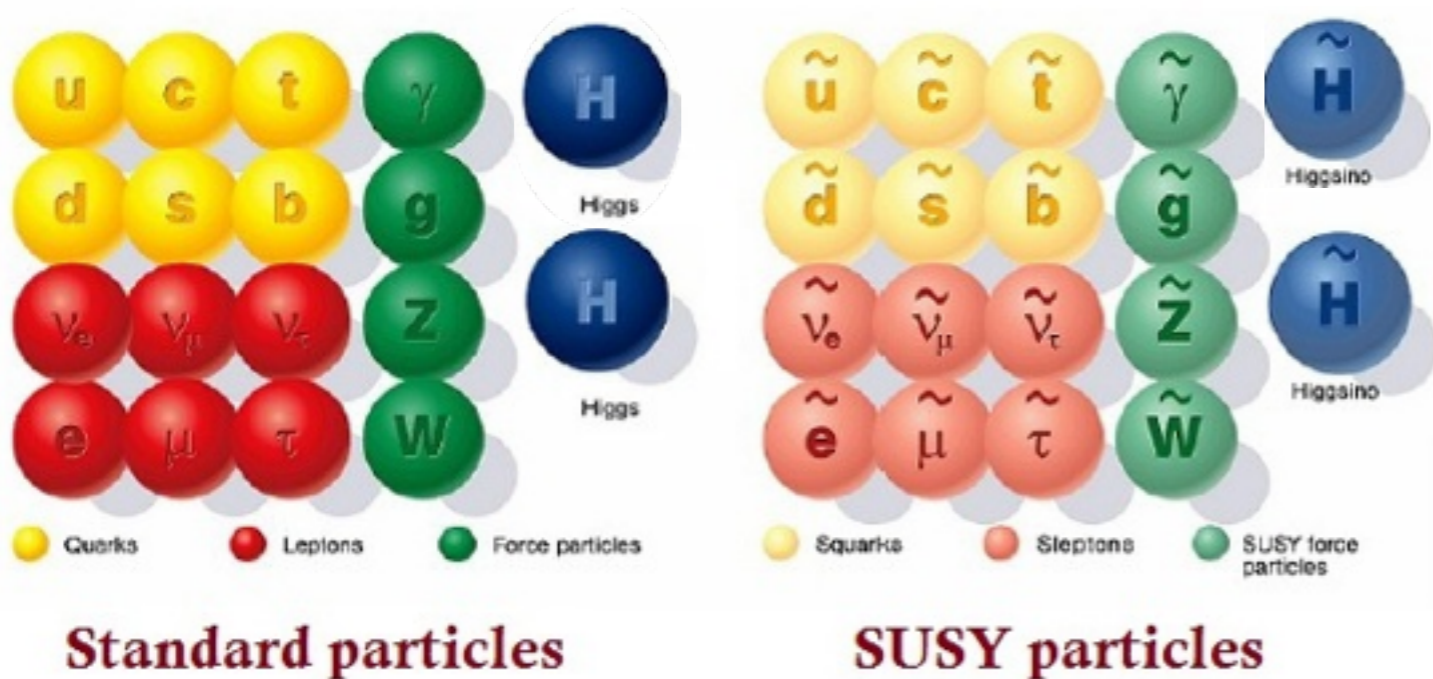

Supersymmetry is a dream of a unified theory of all particles and interactions

	Дальнодействующее (с безмассовым бозоном)	Короткодействующее (с массивными бозонами)	"Конфайнментовое"
Спин 0 (скалярные поля)		Хиггсовское $V(r) \sim \frac{A}{r} e^{-Br}$	
Спин 1 (векторные поля)	Электромагнитное $V(r) \sim \frac{A}{r}$	Слабое $V(r) \sim \frac{A}{r} e^{-Br}$	Сильное $V(r) \sim \frac{A}{r} + Cr$
Спин 2 (тензорные поля)	Гравитационное $V(r) \sim \frac{A}{r}$		

Why SUSY?

- Unification of the gauge couplings
- Solution of the hierarchy problem
- Explanation of the EW symmetry violation
- Provided the DM particle
- Unification with gravity!

$$\{Q_\alpha^i, \bar{Q}_\beta^j\} = 2\delta^{ij} (\sigma^\mu)_{\alpha\beta} P_\mu \Rightarrow \{\delta_\varepsilon, \bar{\delta}_\varepsilon\} = 2(\varepsilon\sigma^\mu\bar{\varepsilon})P_\mu$$

$\varepsilon = \varepsilon(x)$ local coordinate transf. \Rightarrow (super)gravity

Local supersymmetry = general relativity !

Creation and decay of superpartners @ LHC

Weak int's

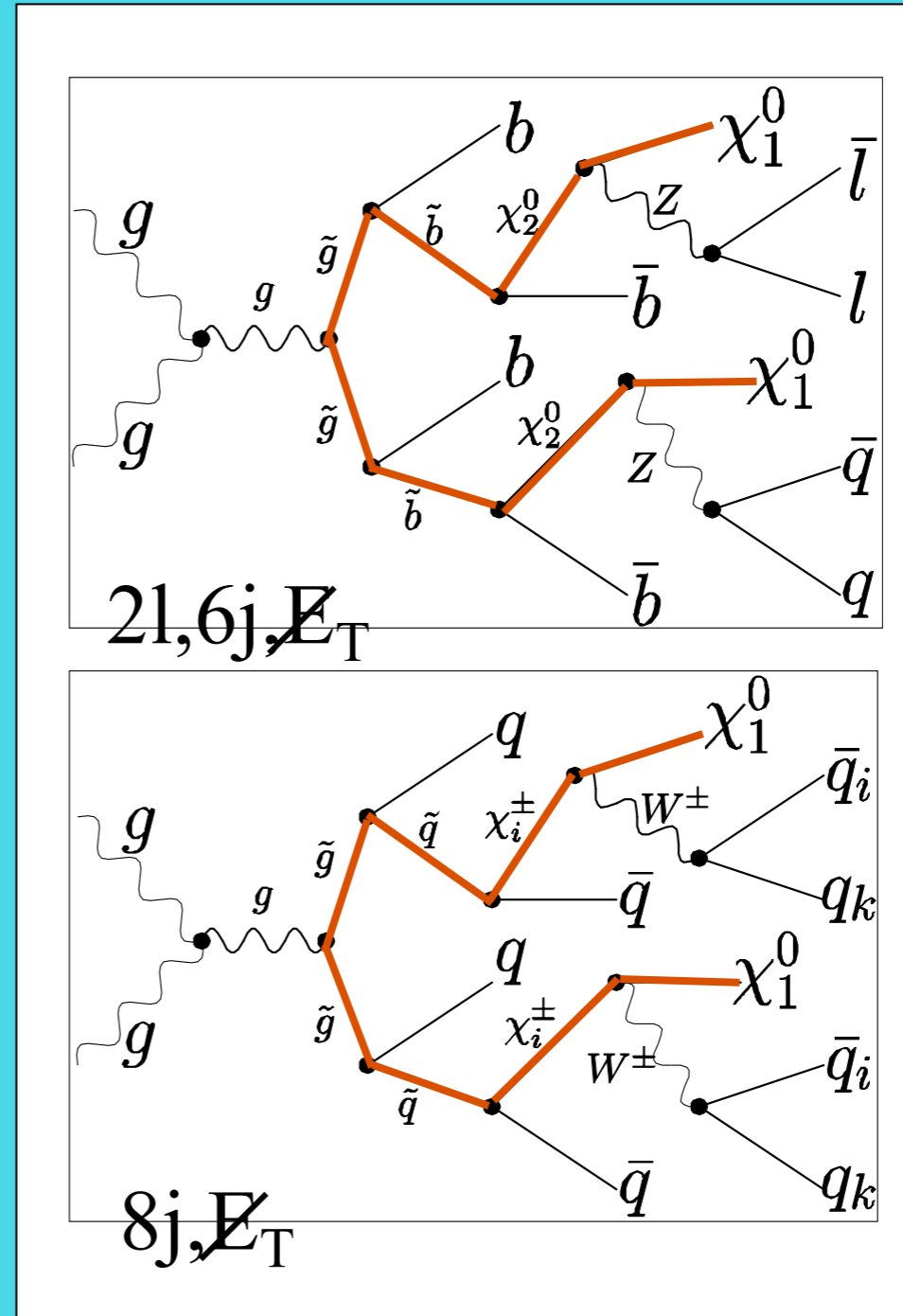
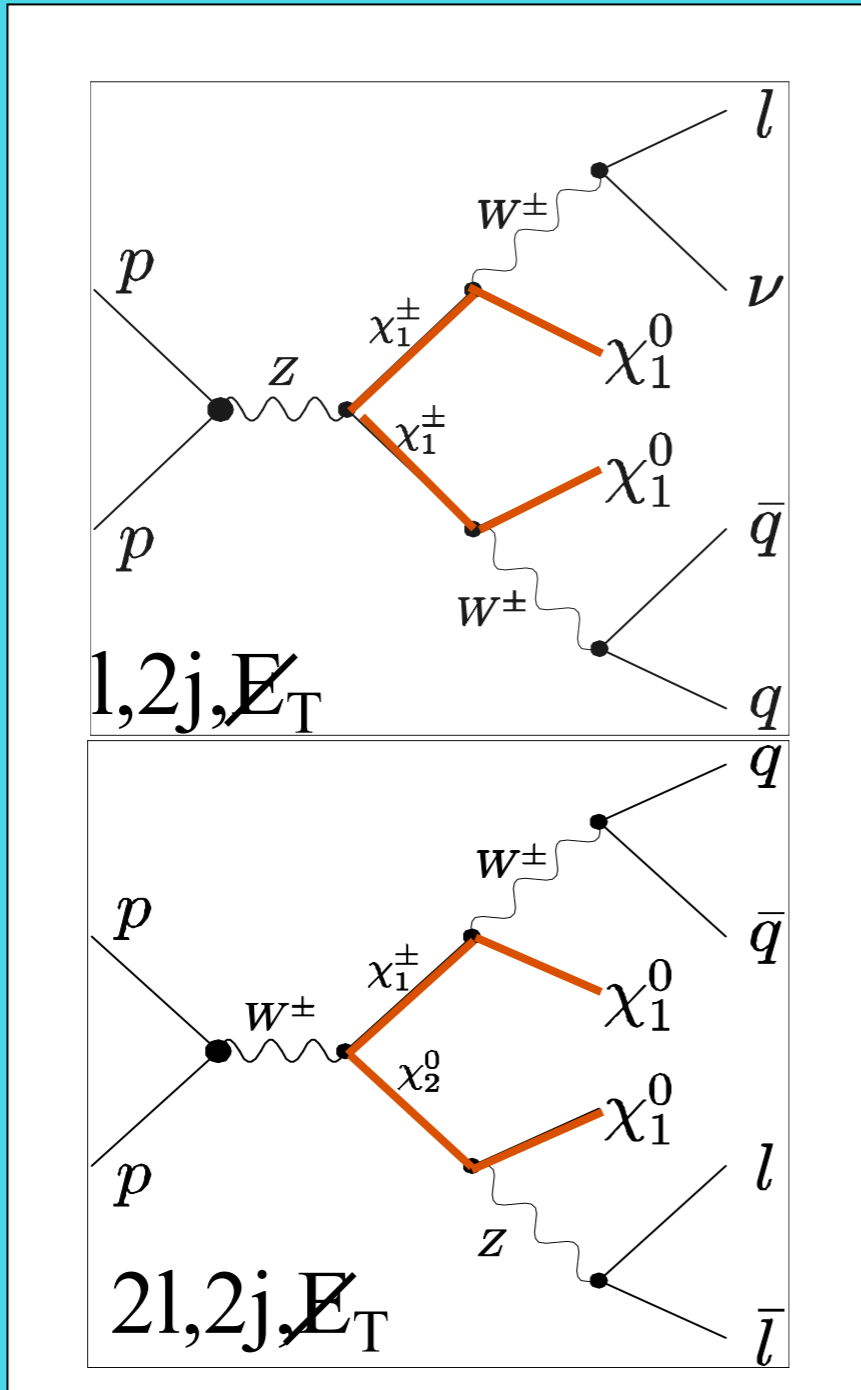

Strong int's

Typical SUSY signature: missing energy and transverse momentum

Creation and decay of superpartners @ LHC

Weak int's

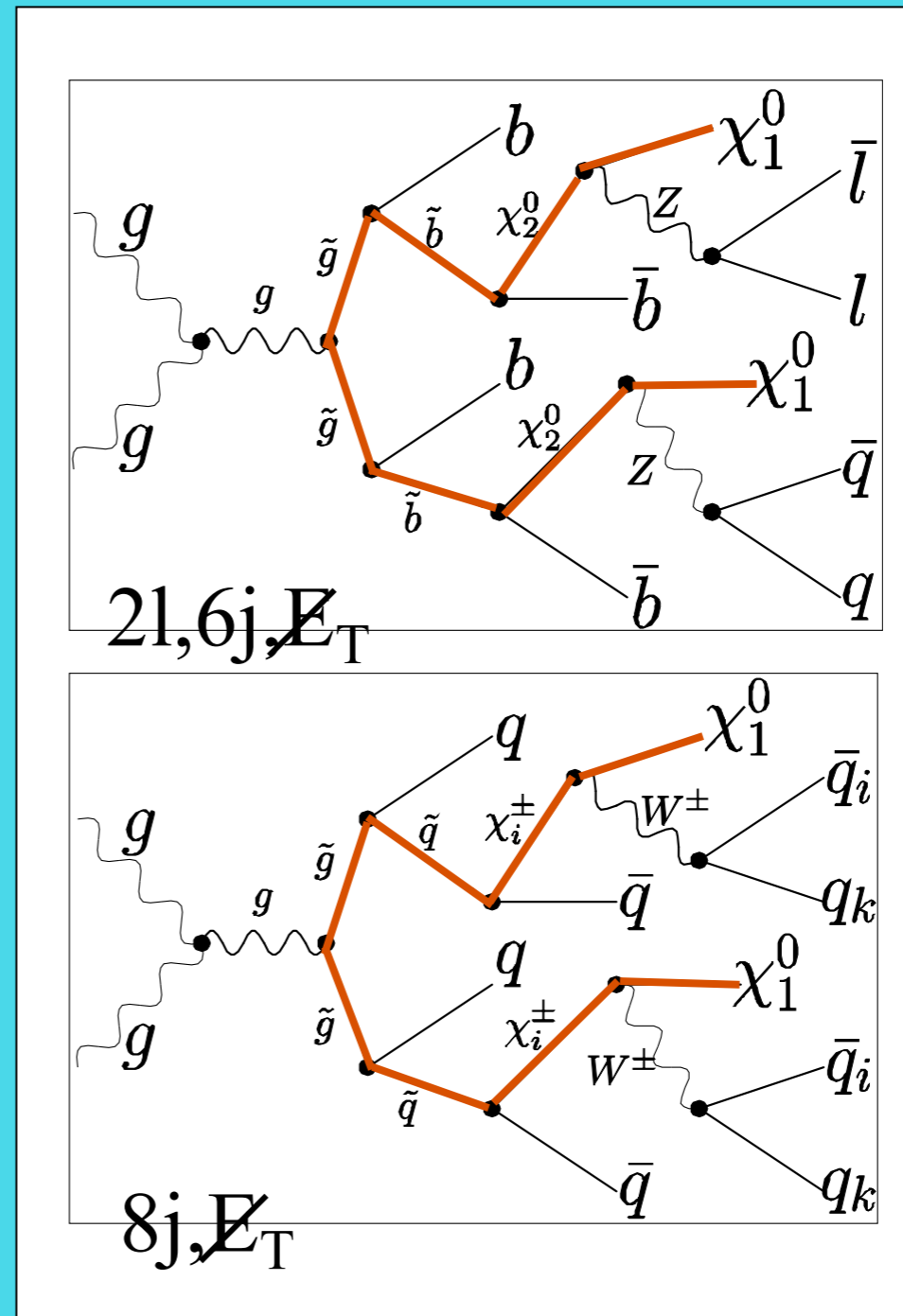
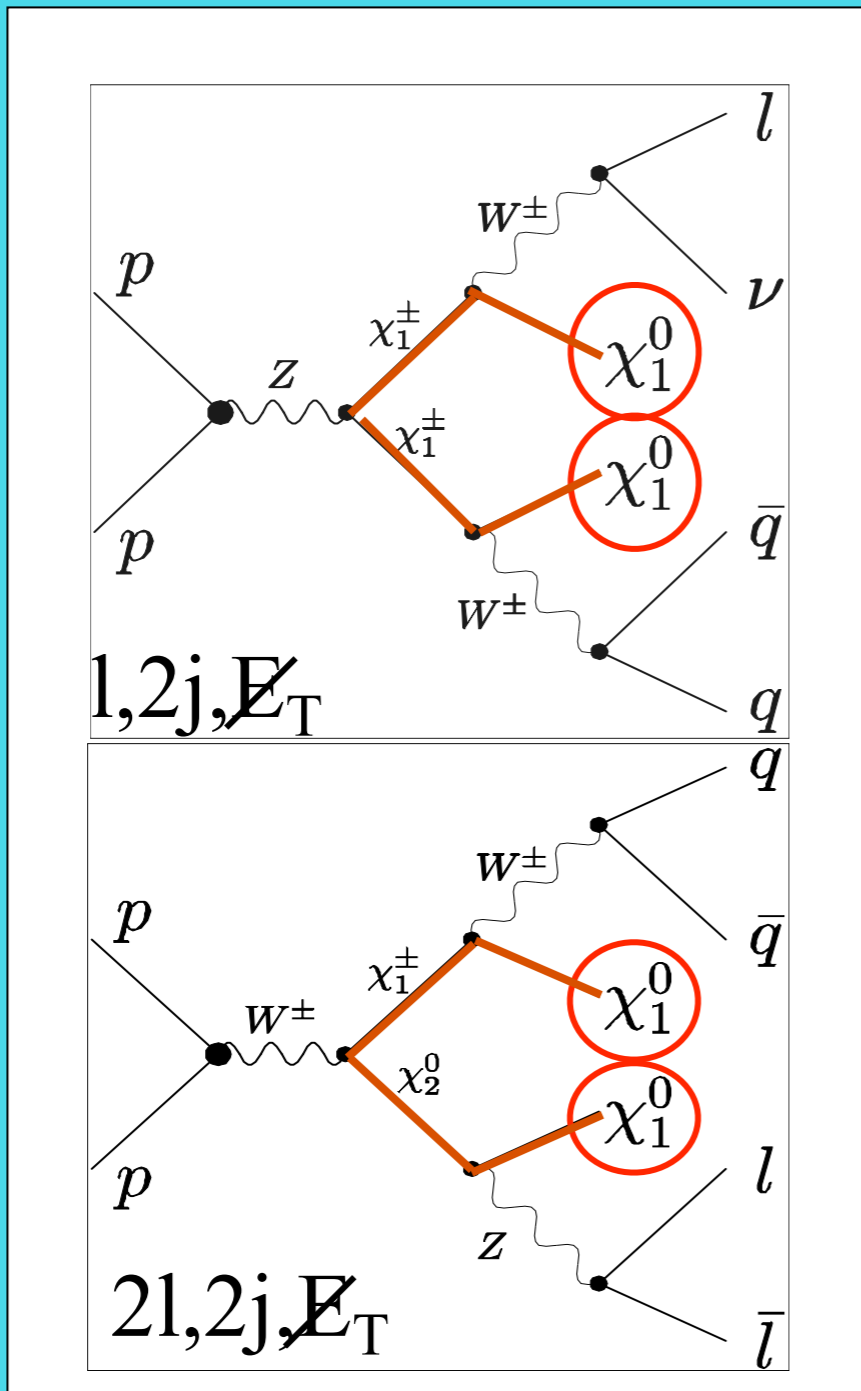

Strong int's

Typical SUSY signature: missing energy and transverse momentum

Creation and decay of superpartners @ LHC

Weak int's

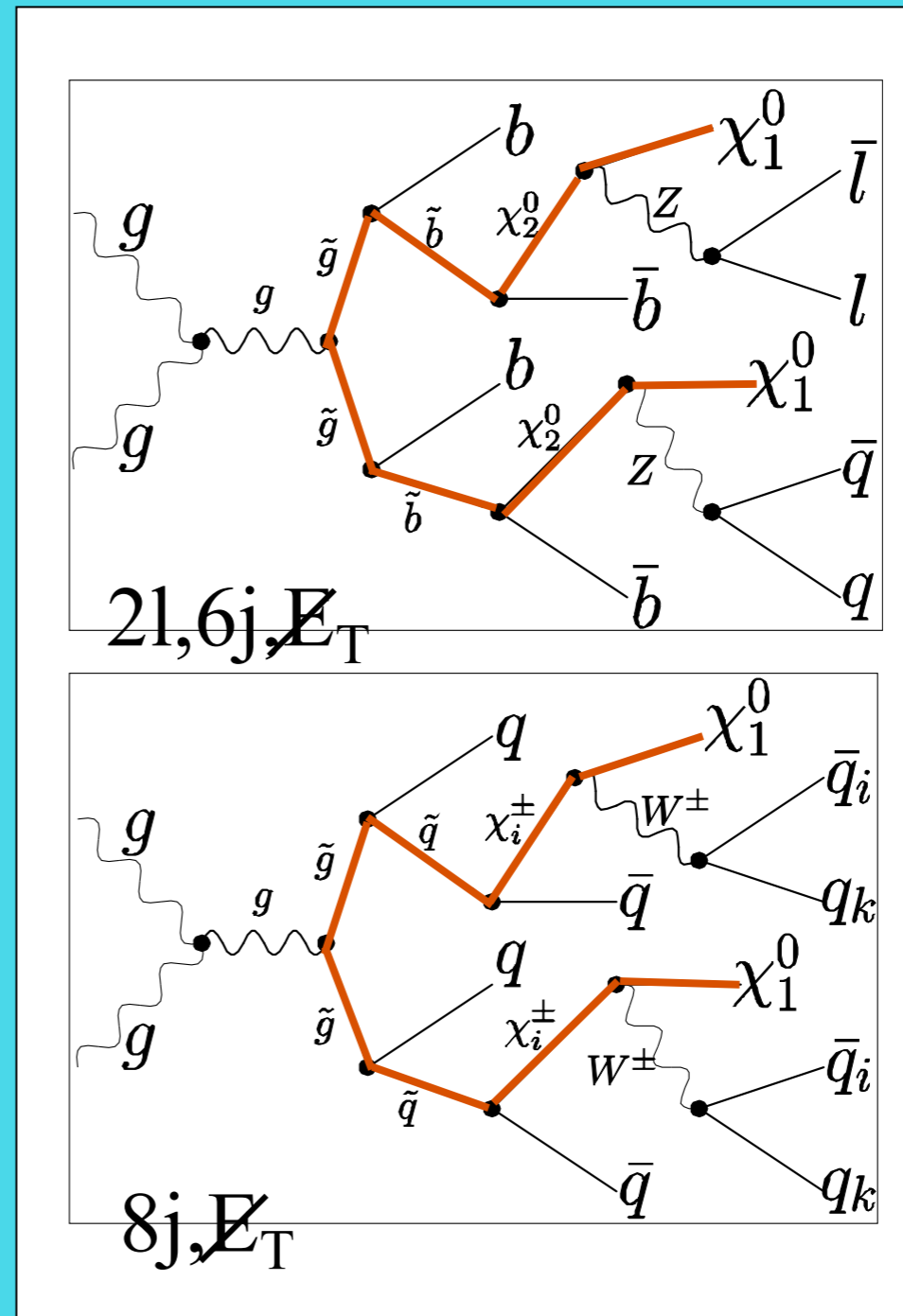
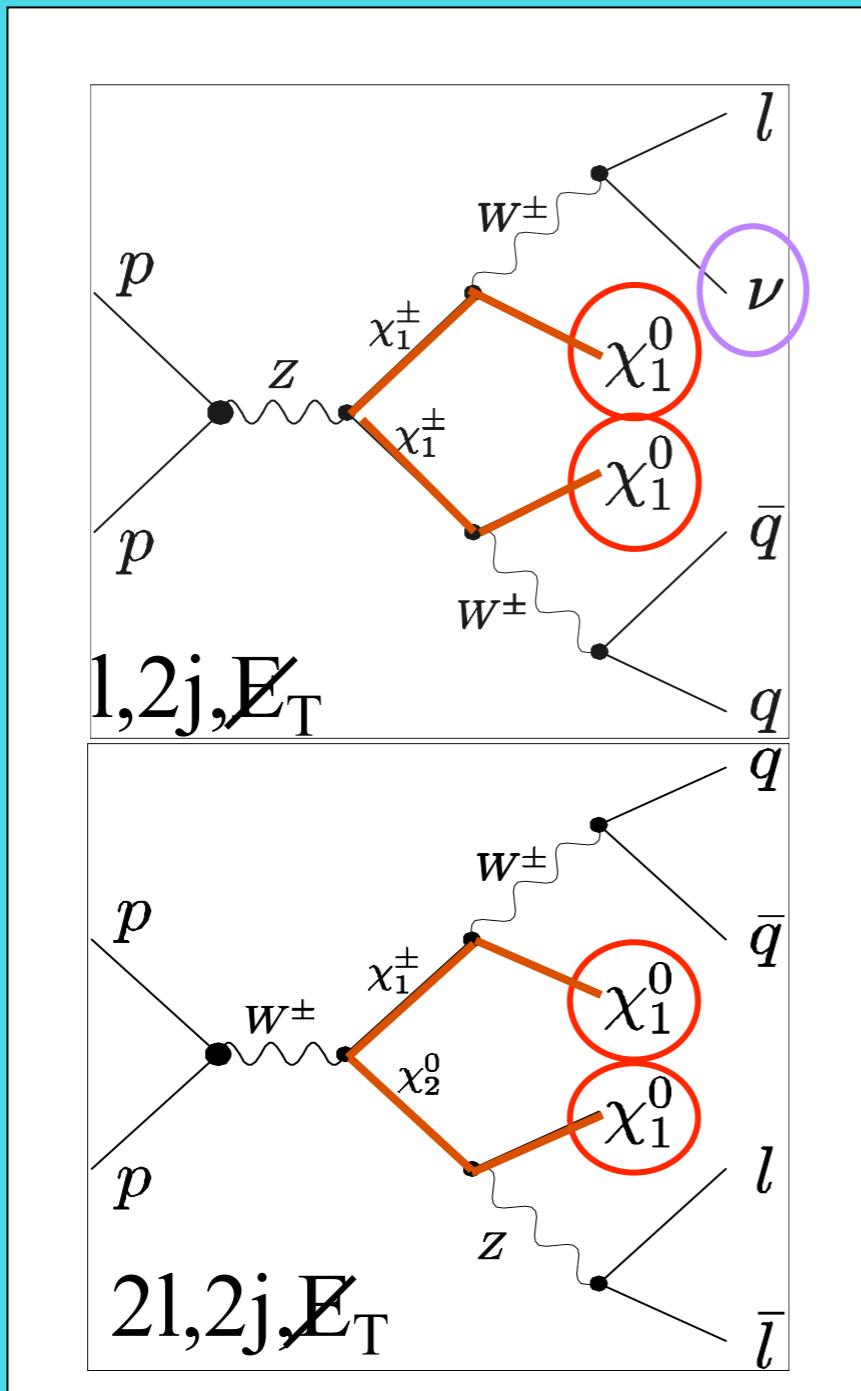

Strong int's

Typical SUSY signature: missing energy and transverse momentum

Creation and decay of superpartners @ LHC

weak int's

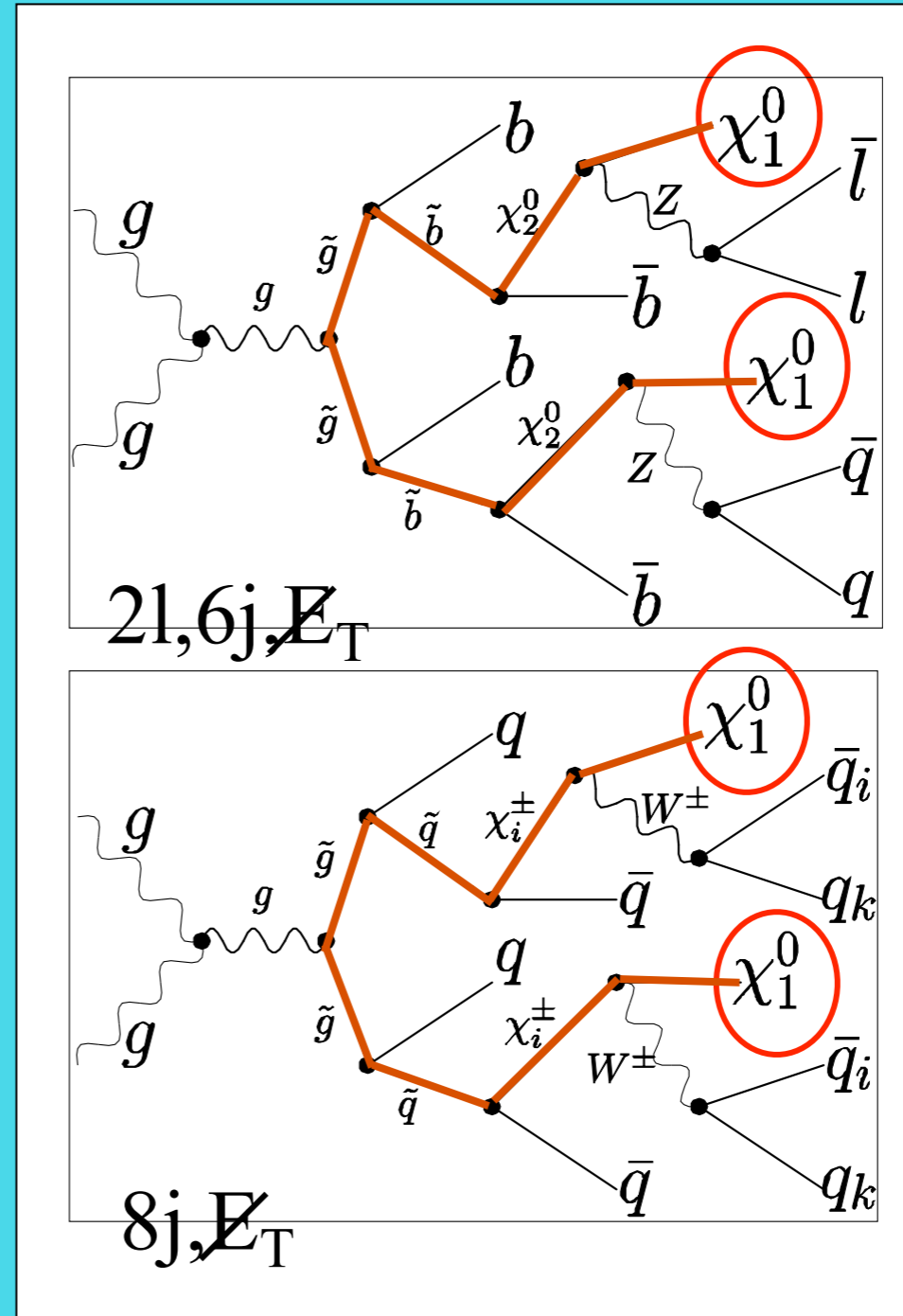
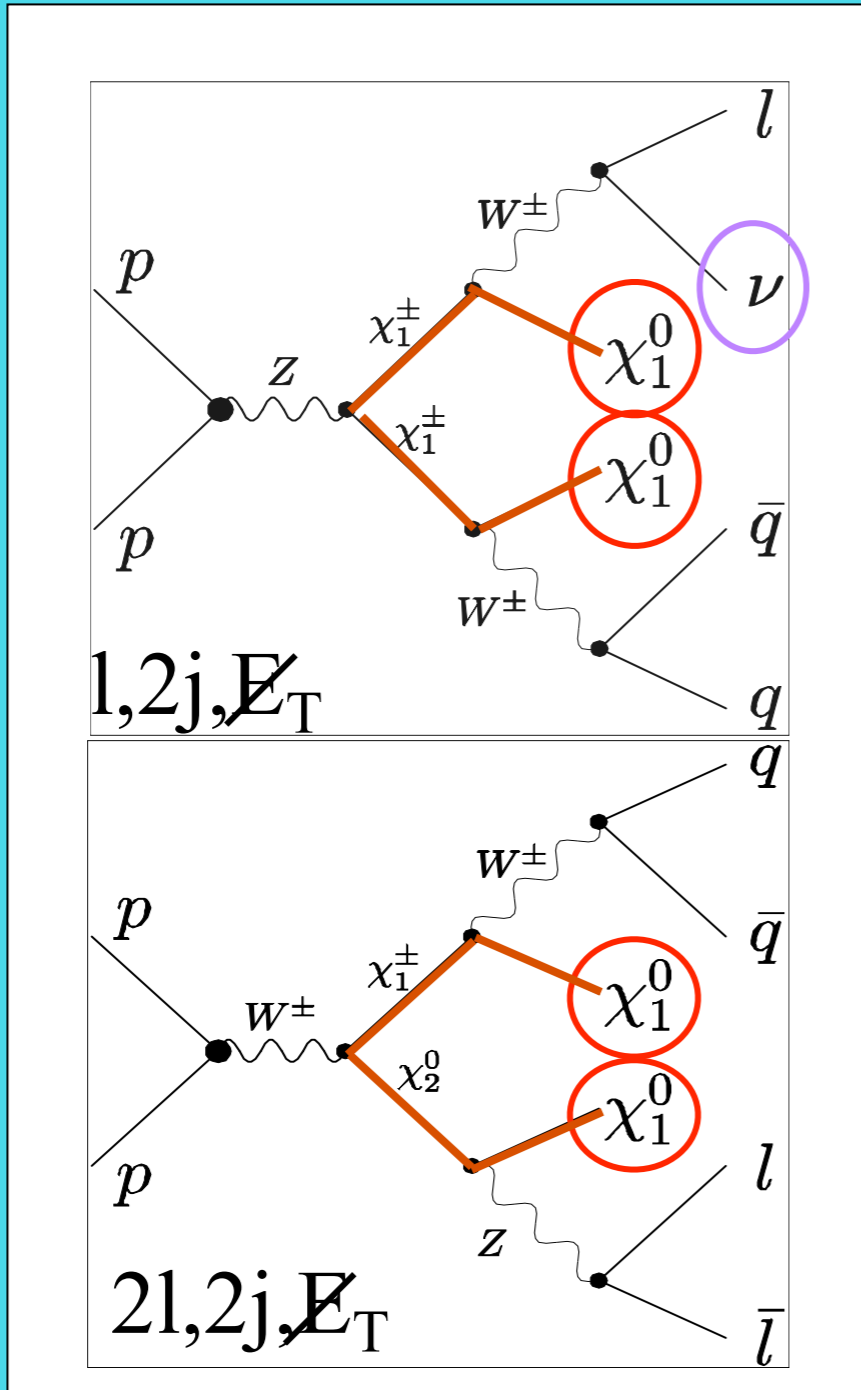

Strong int's

Typical SUSY signature: missing energy and transverse momentum

Search for Supersymmetry @ LHC

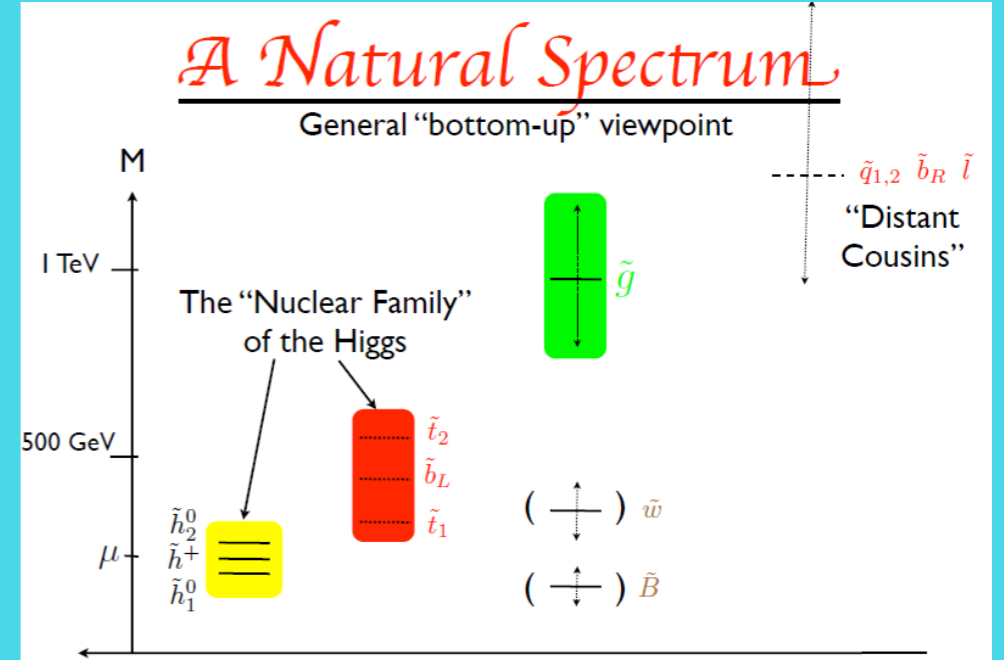
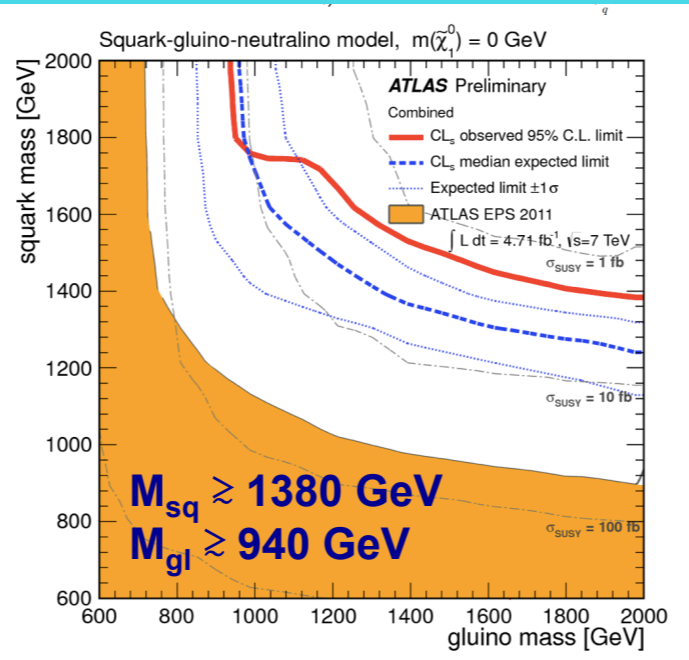
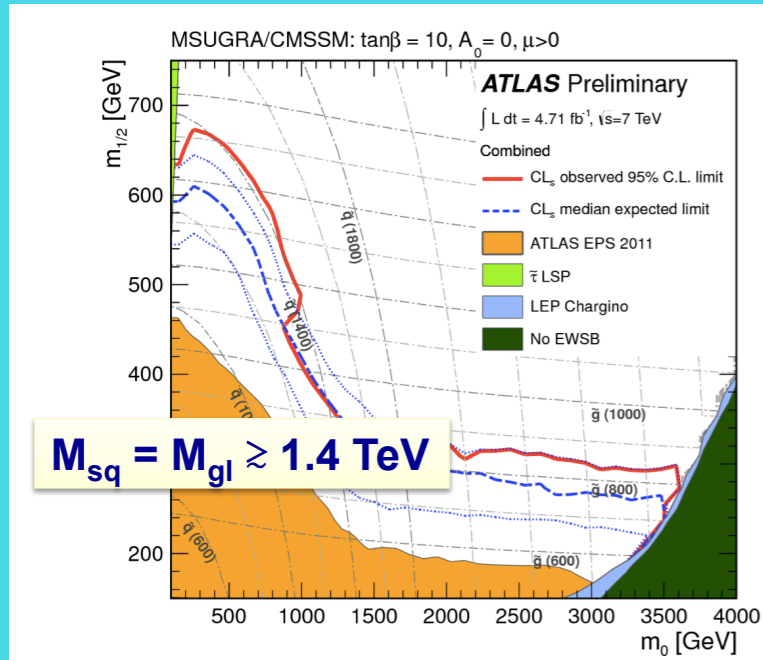

Weakly interacting particles

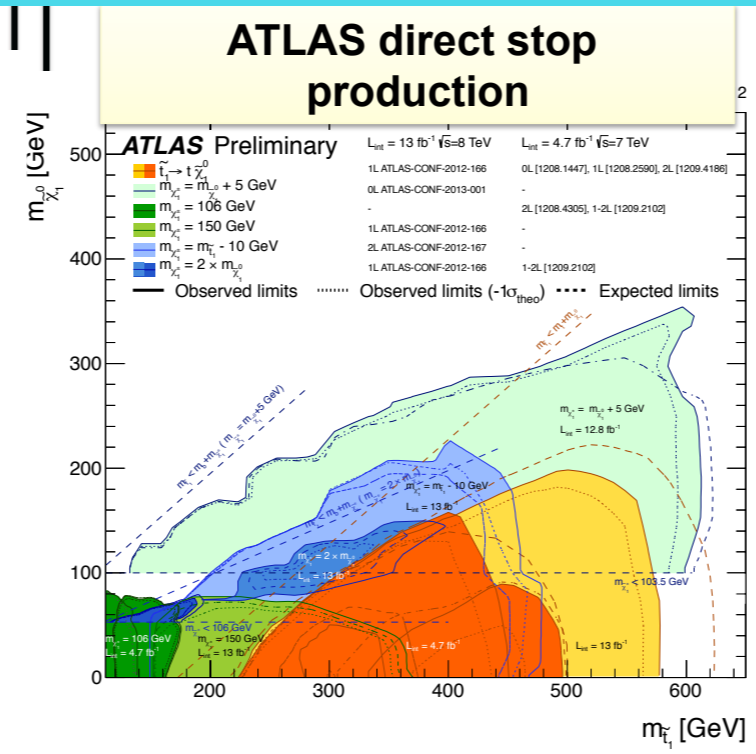
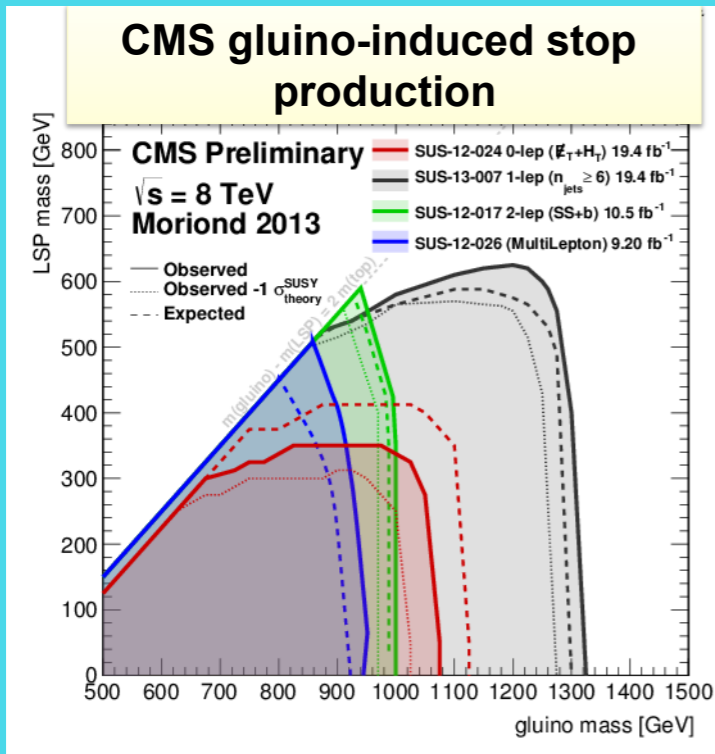

Strongly interacting particles

Search for Supersymmetry @ LHC

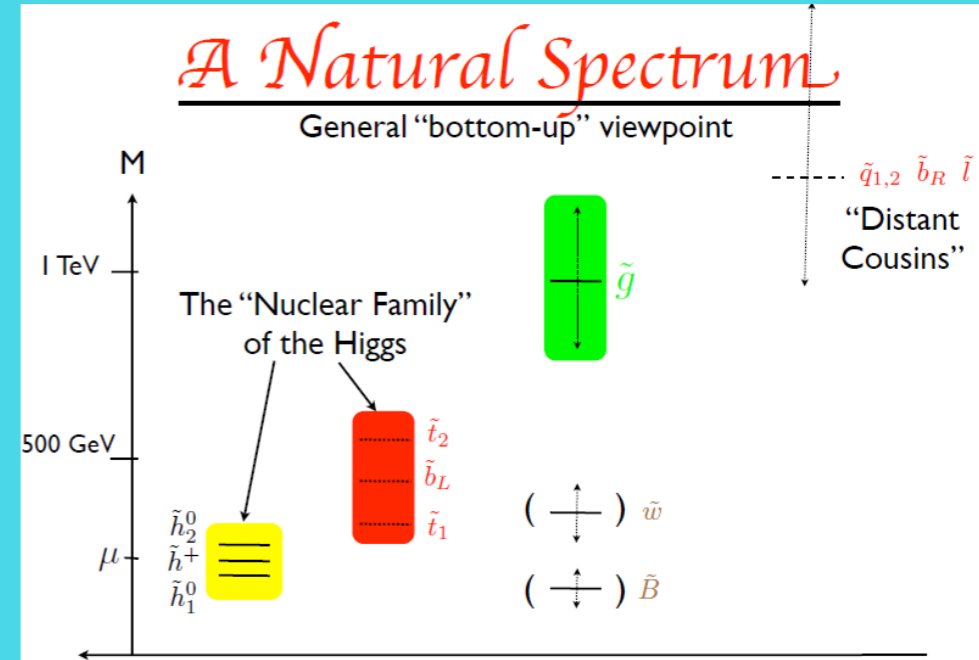
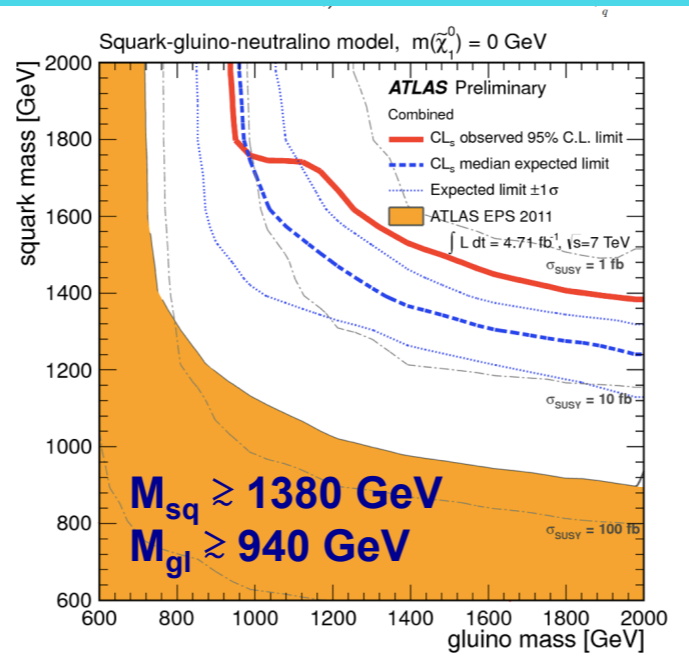
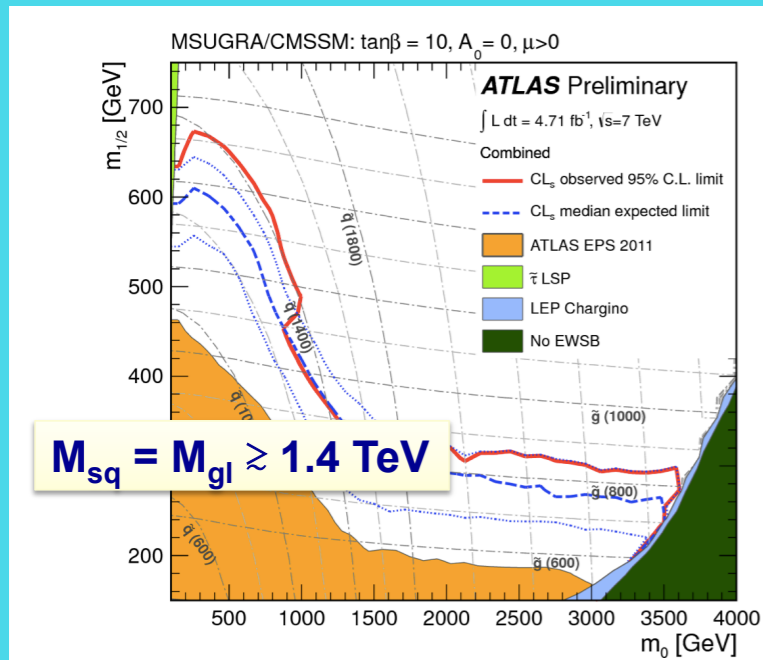

Weakly interacting particles

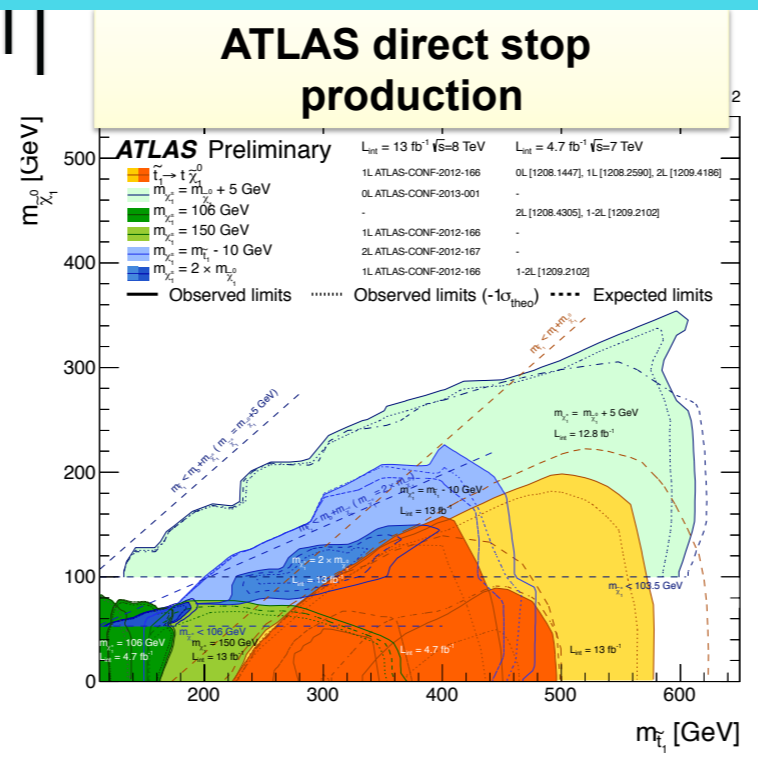
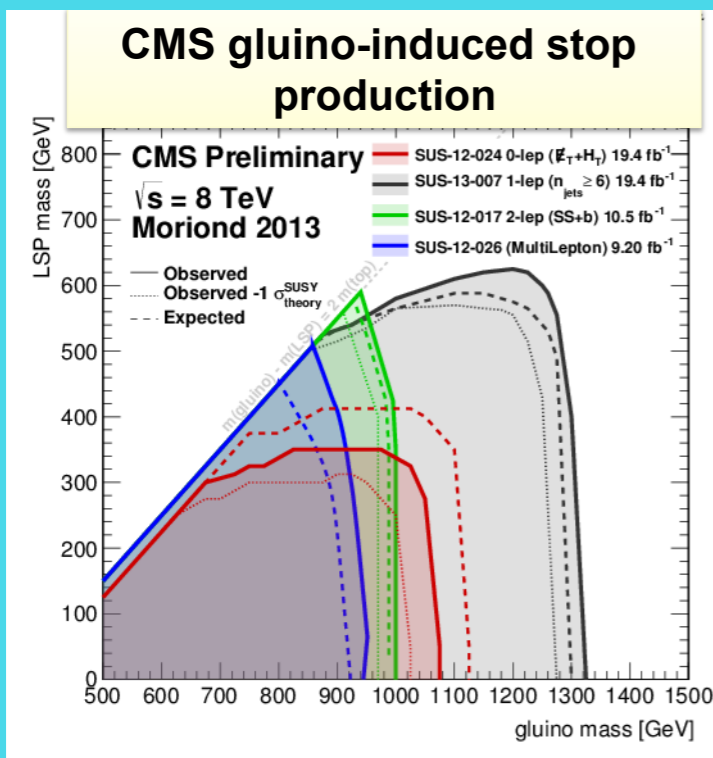

Strongly interacting particles

Tremendous progress of the LHC on SUSY searches is disappointing so far.

Search for Supersymmetry @ LHC

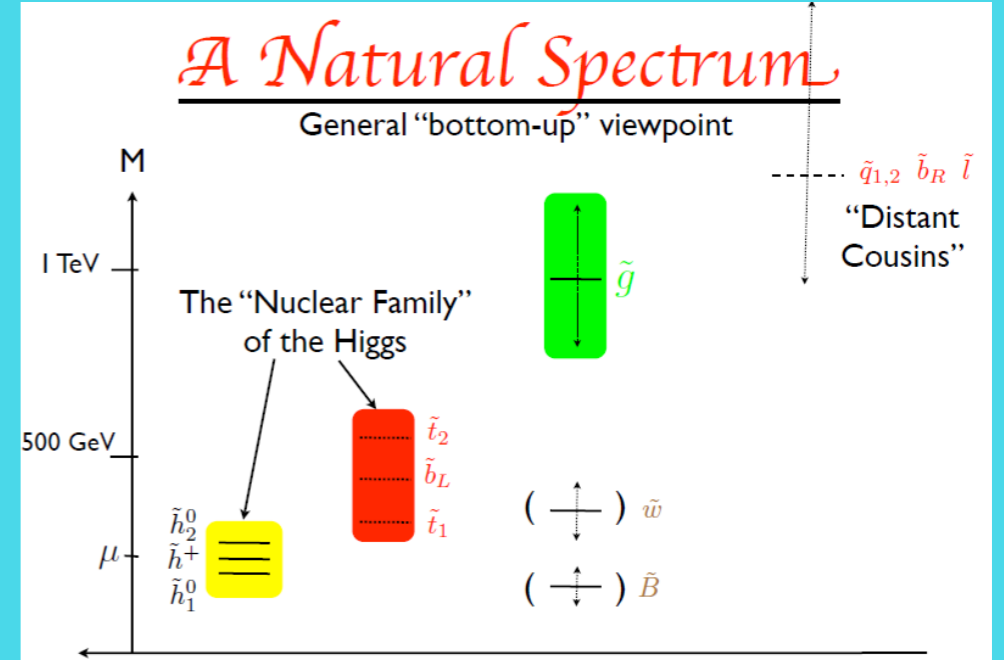
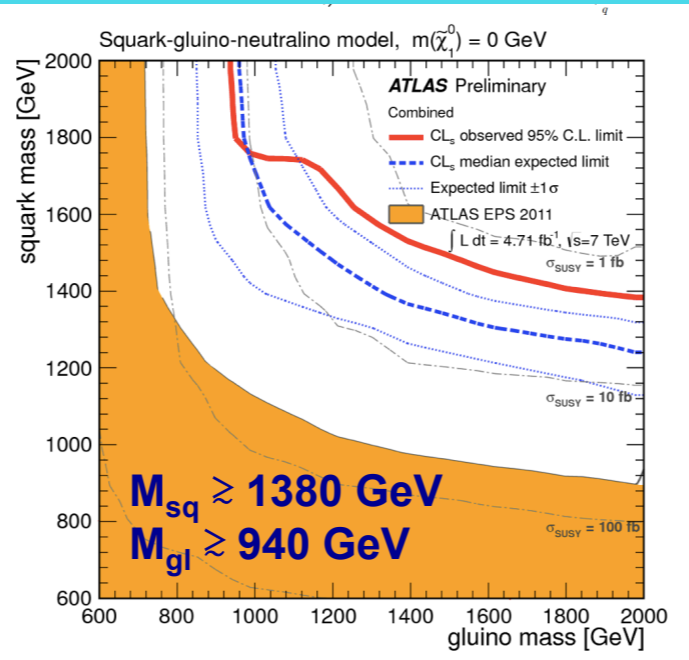
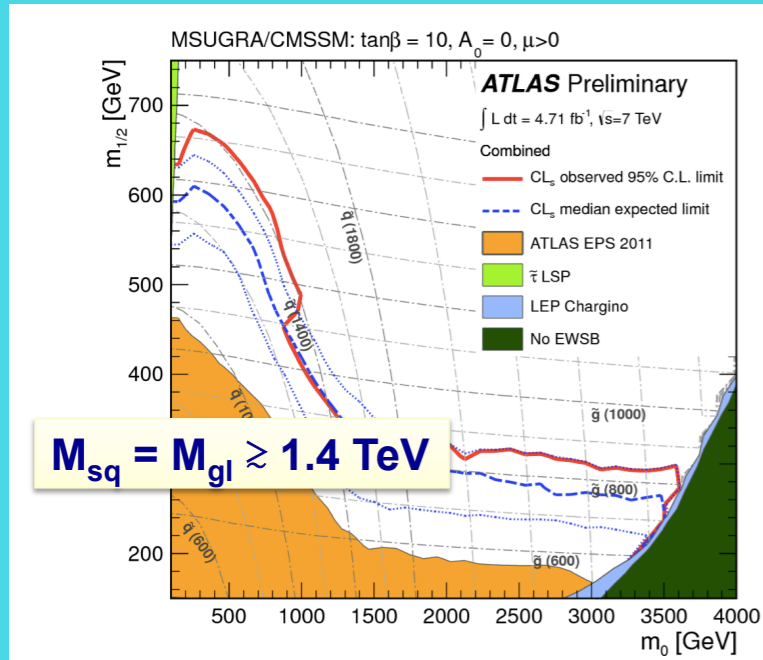

Weakly interacting particles

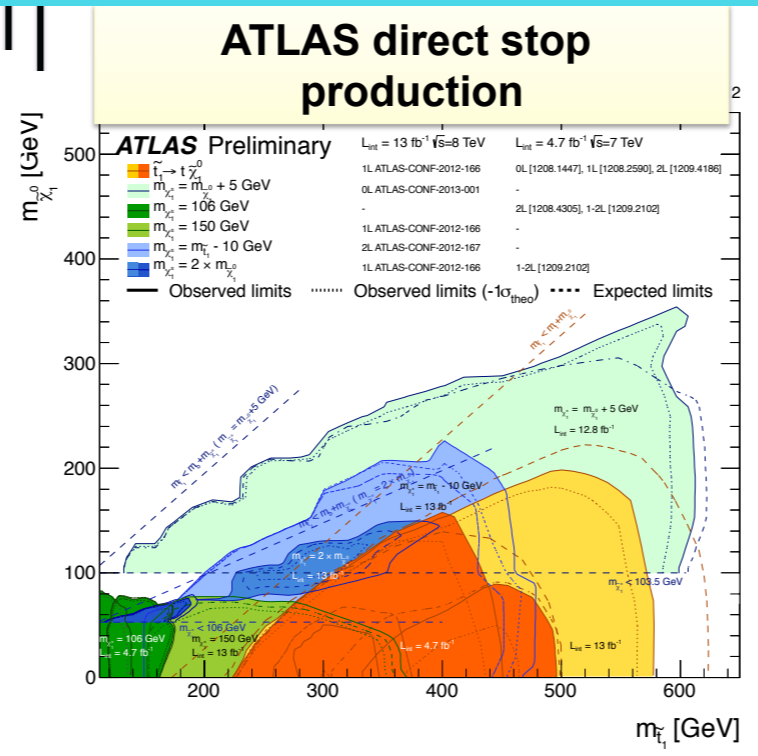
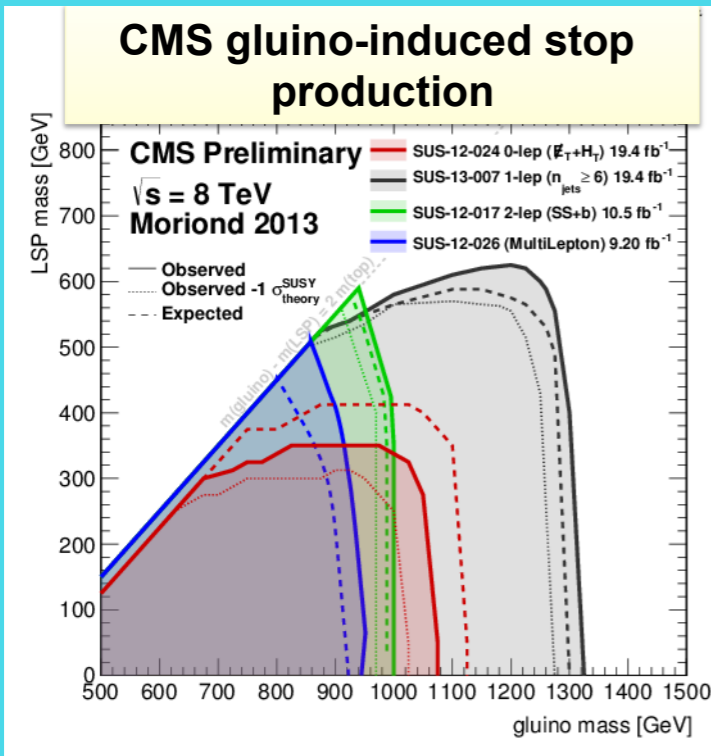

Strongly interacting particles

Tremendous progress of the LHC on SUSY searches is disappointing so far.

Looking in wrong place?

Search for Supersymmetry @ LHC

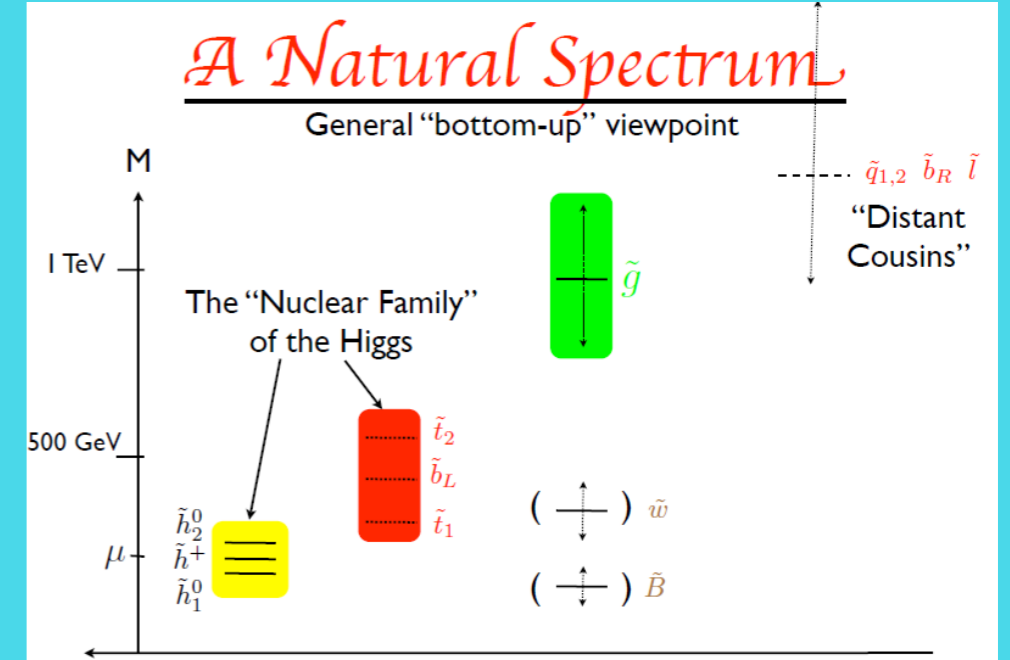
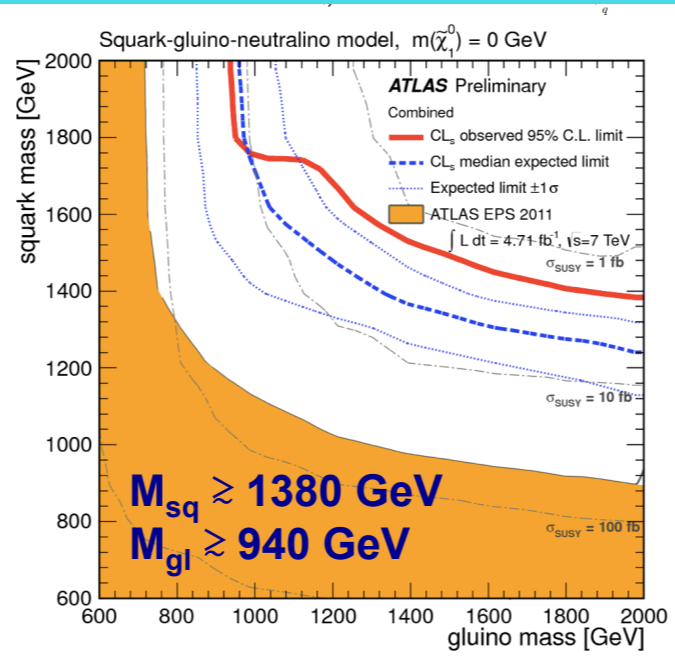
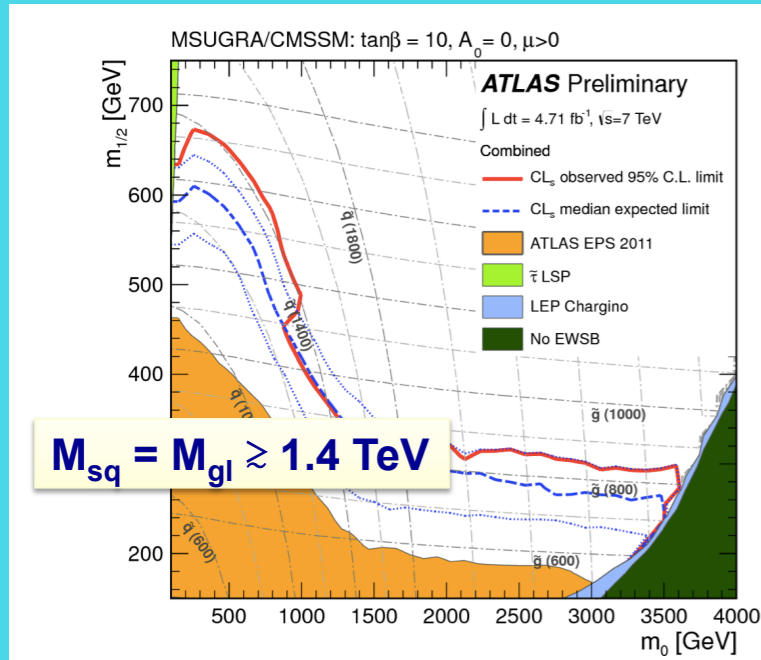

Weakly interacting particles

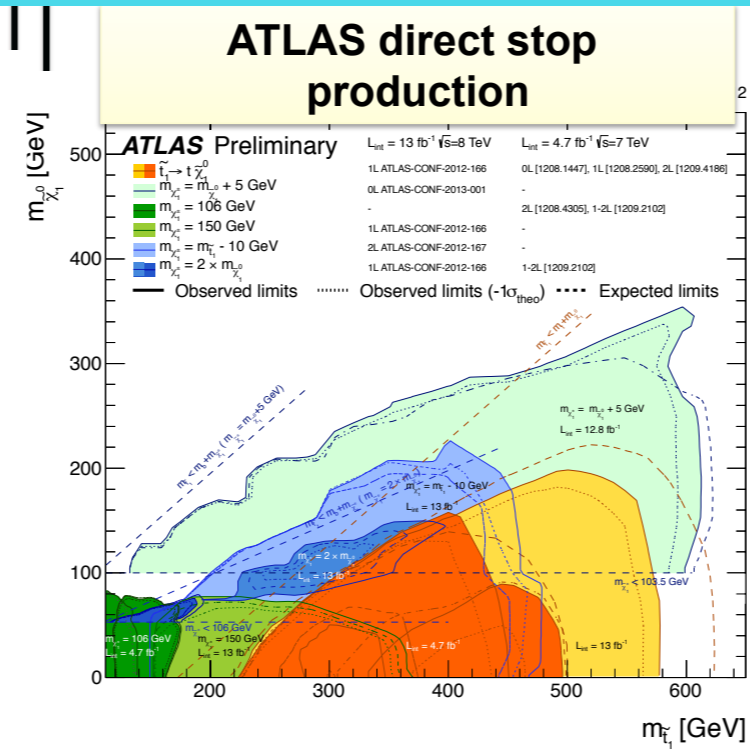
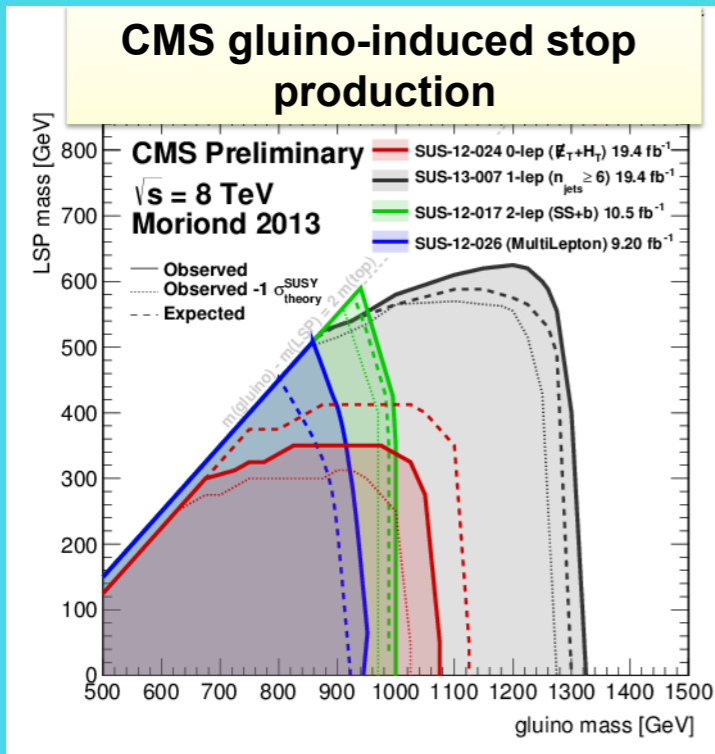

Tremendous progress of the LHC on SUSY searches is disappointing so far.

Looking in wrong place?

Still have not reached the the right mass interval?

Strongly interacting particles

Search for Supersymmetry @ LHC

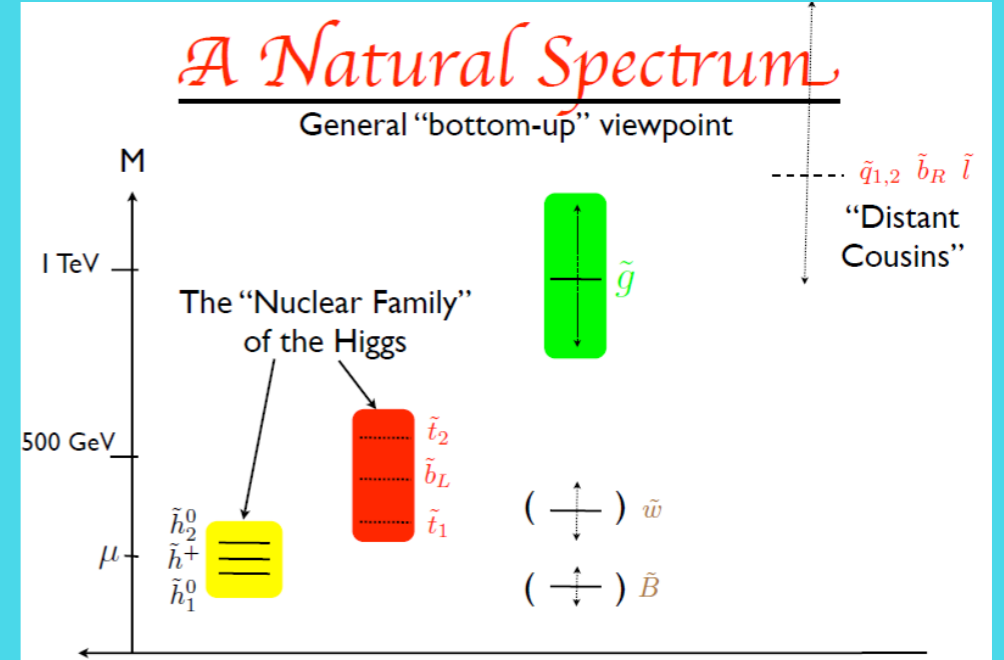
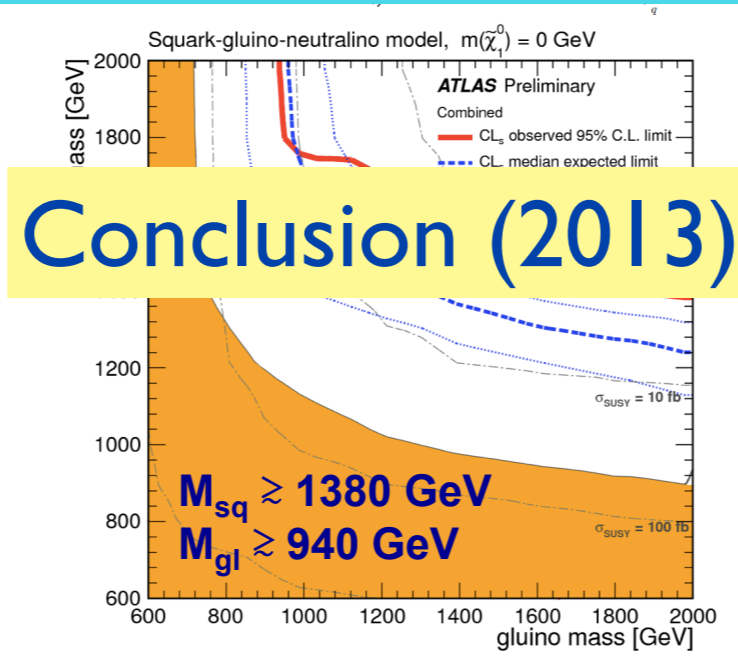
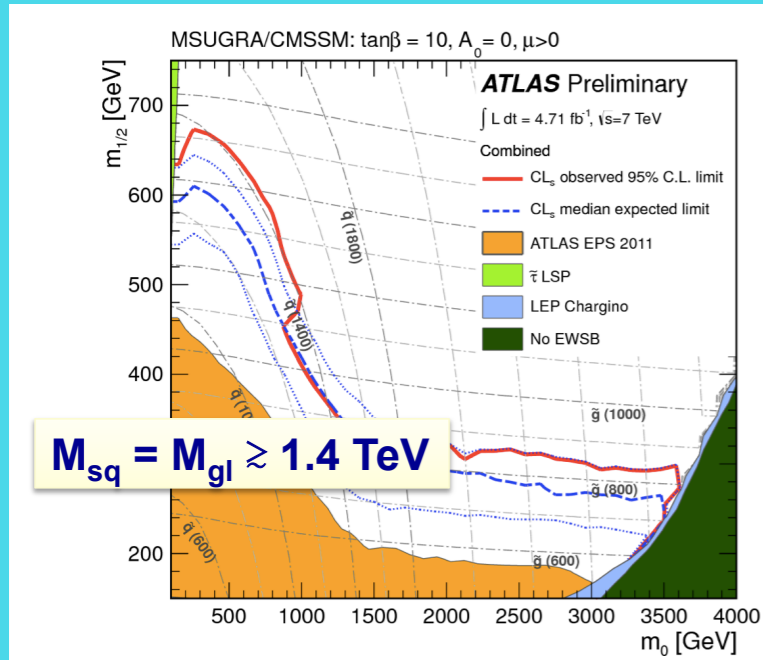

Weakly interacting particles

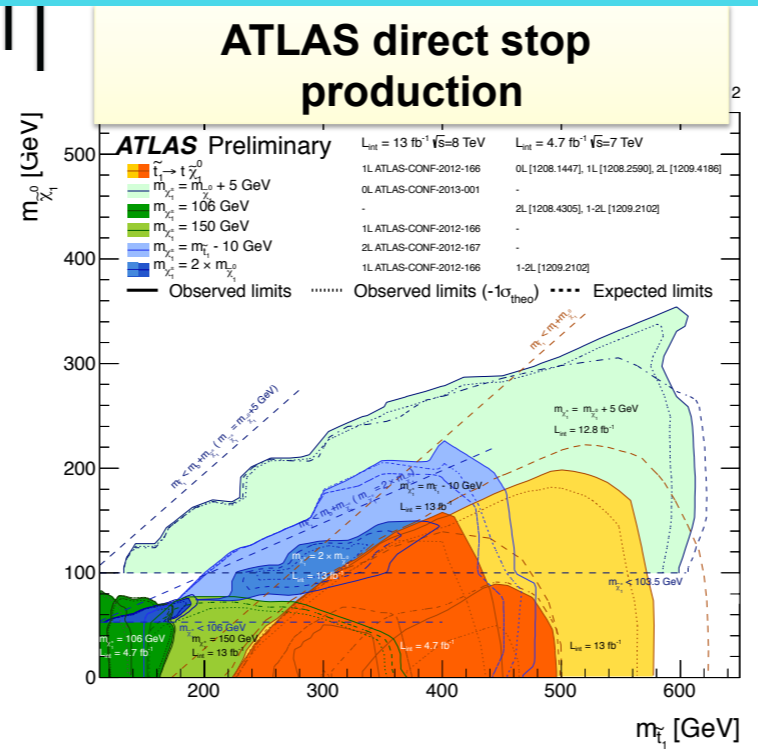
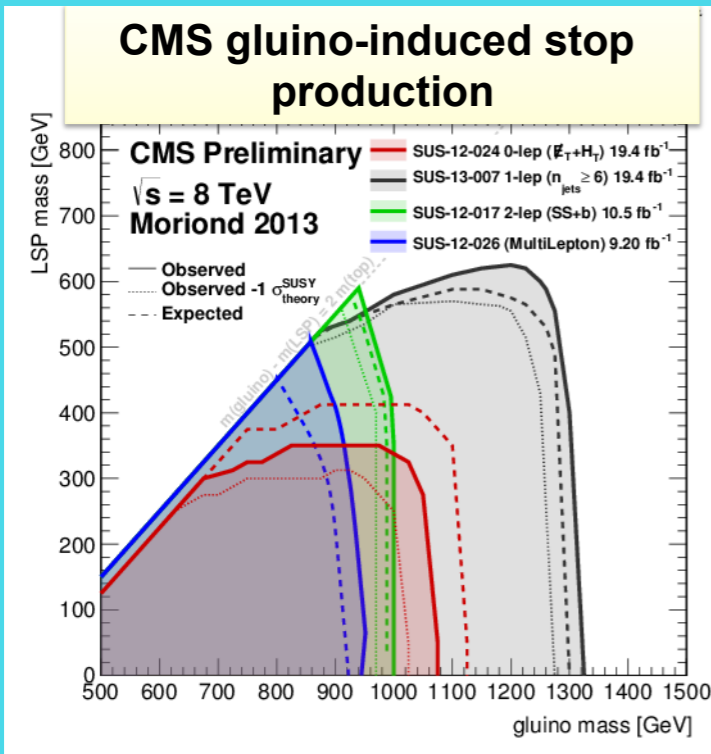

Tremendous progress of the LHC on SUSY searches is disappointing so far.

Looking in wrong place?

Still have not reached the the right mass interval?

Strongly interacting particles

Search for Supersymmetry @ LHC

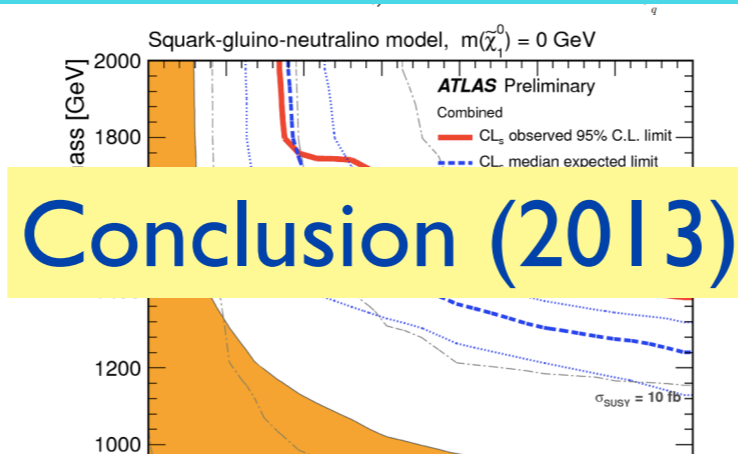
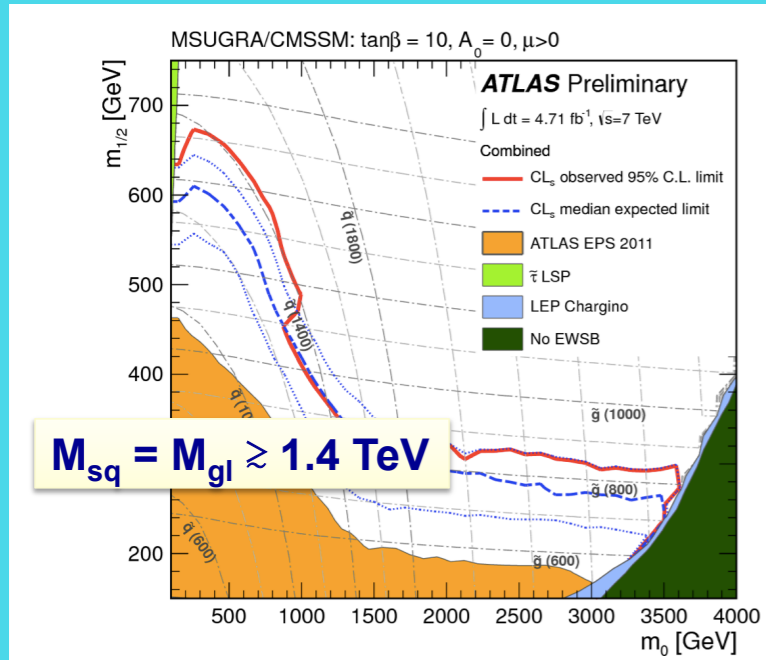

Conclusion (2013)

I. Still no sign of SUSY

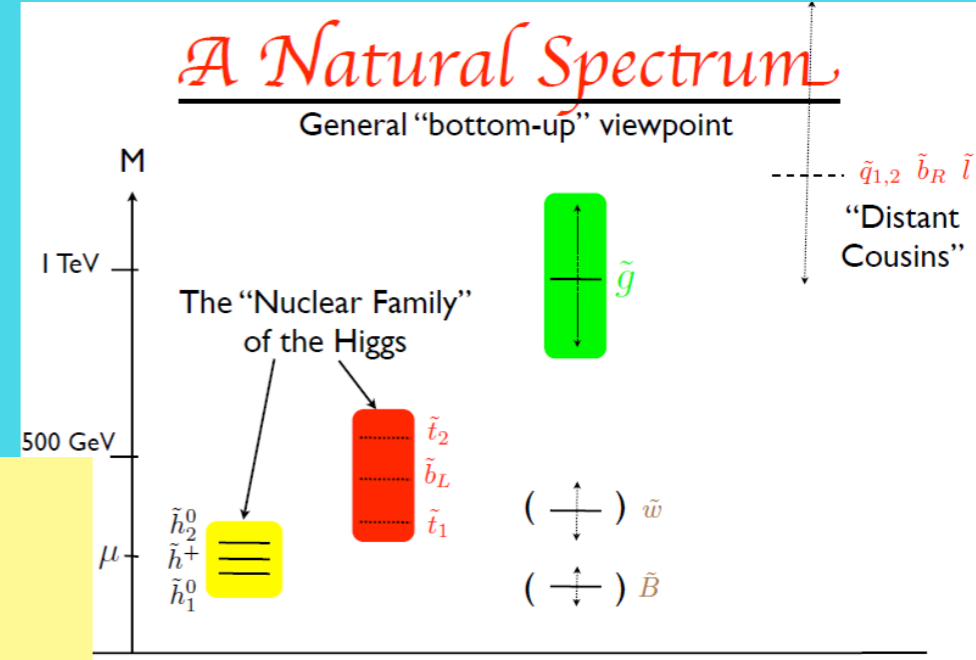

Weakly interacting particles

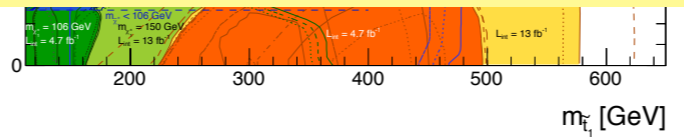
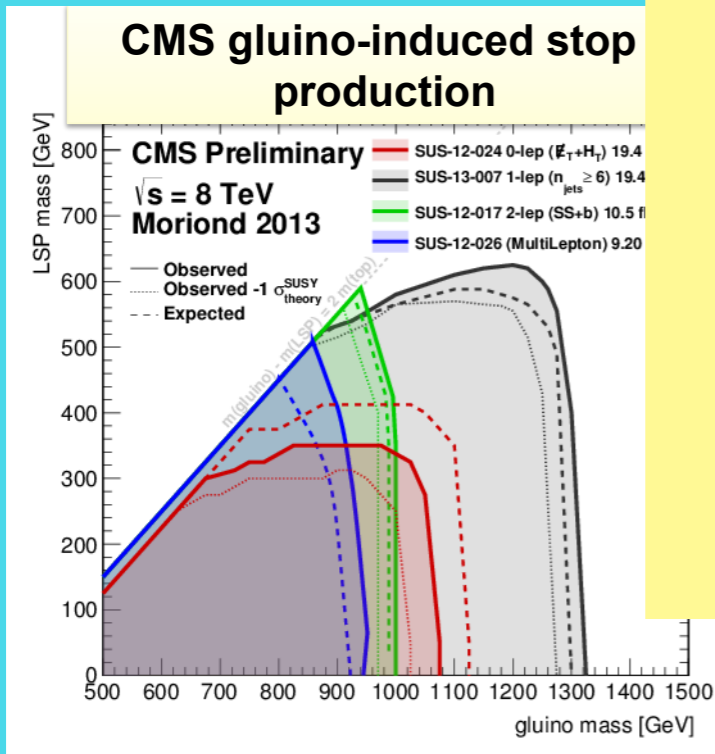

Strongly interacting particles

Tremendous progress of the LHC on SUSY searches is disappointing so far.

Looking in wrong place?

Still have not reached the the right mass interval?

Search for Supersymmetry @ LHC

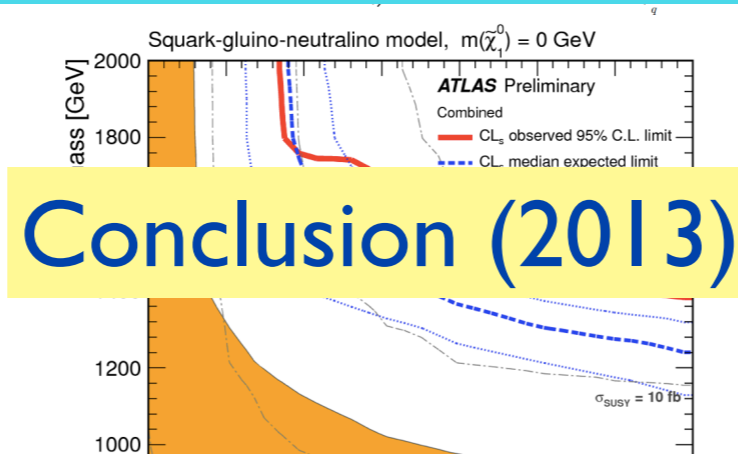
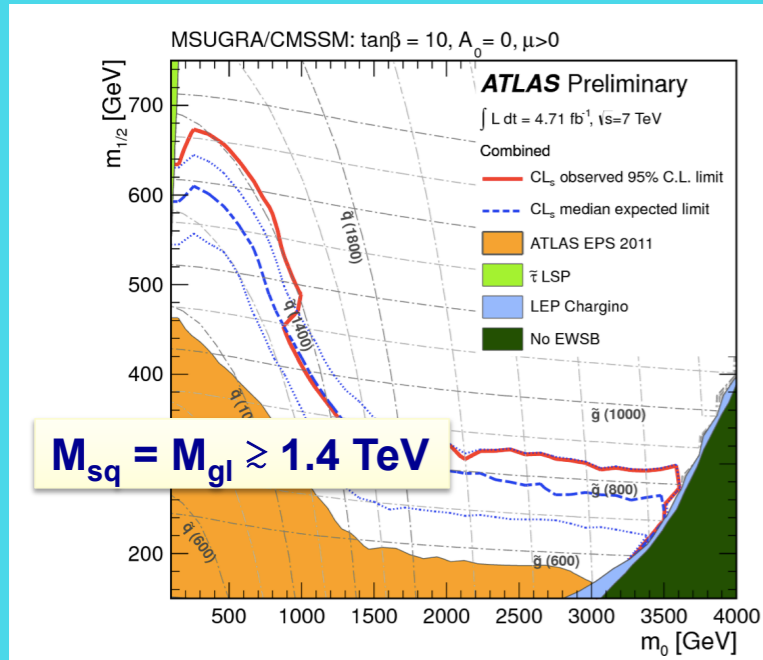

Conclusion (2013)

1. Still no sign of SUSY
2. The obtained constraints are model dependent

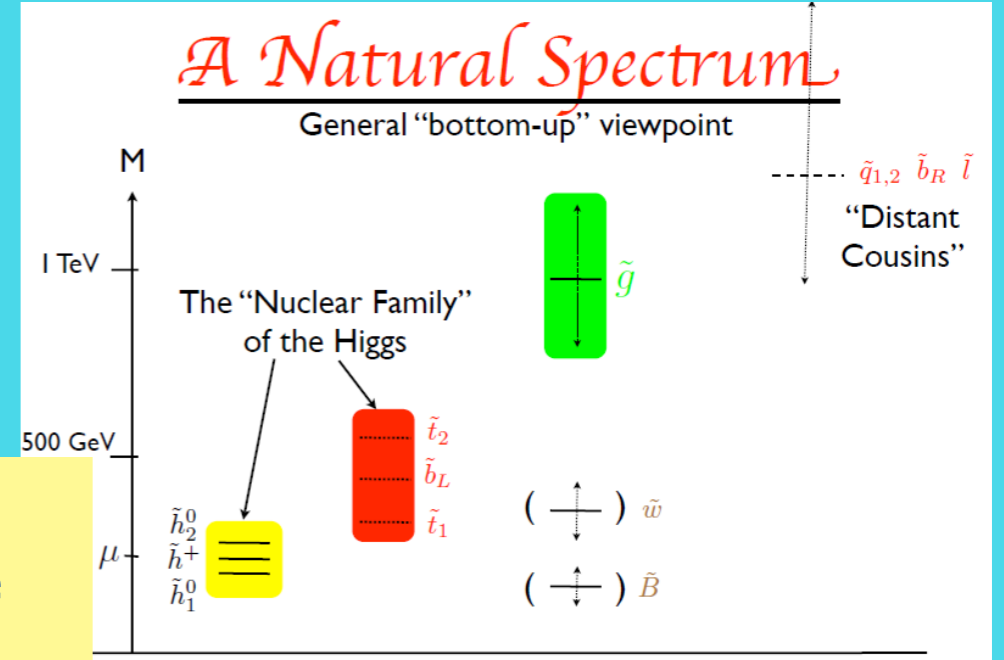

Weakly interacting particles

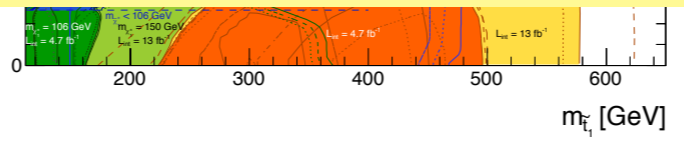
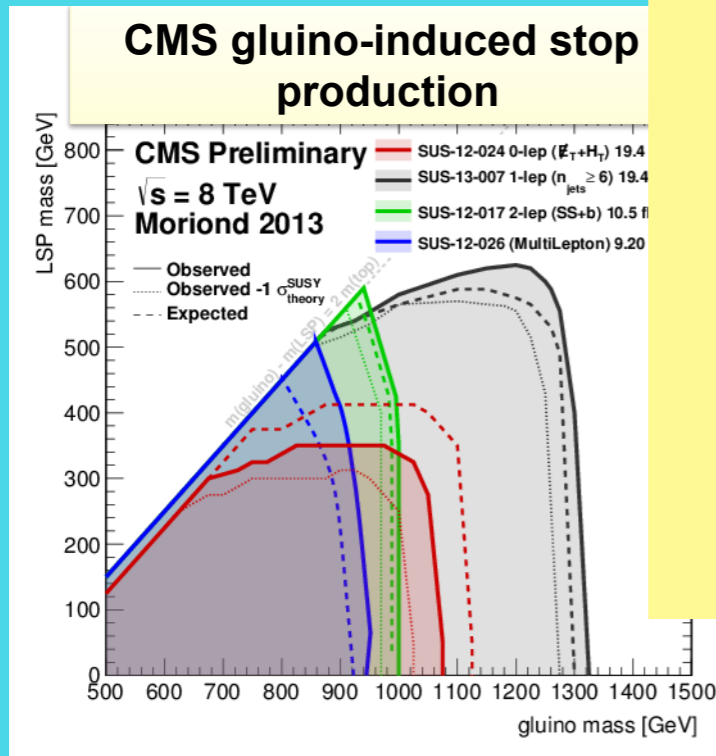

Strongly interacting particles

Tremendous progress of the LHC on SUSY searches is disappointing so far.

Looking in wrong place?

Still have not reached the the right mass interval?

Search for Supersymmetry @ LHC

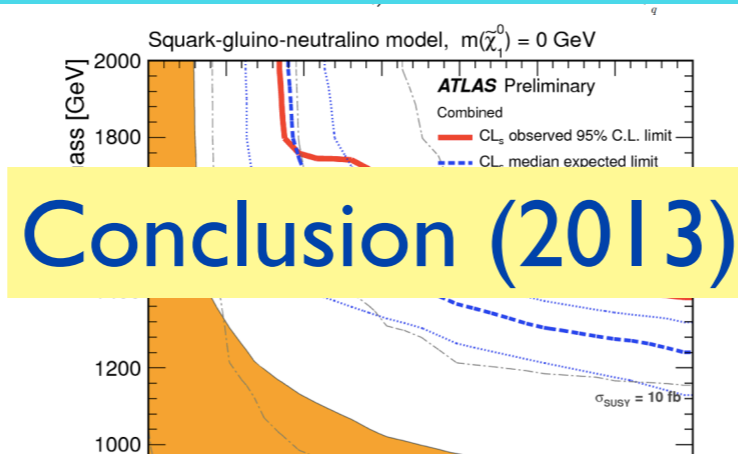
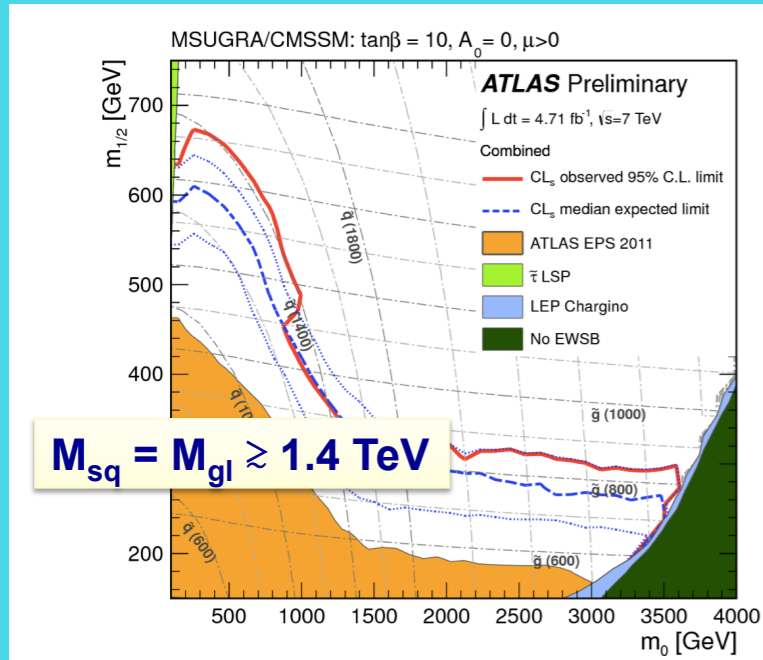

Conclusion (2013)

1. Still no sign of SUSY
2. The obtained constraints are model dependent
3. The models have many parameters and still there is large room for SUSY

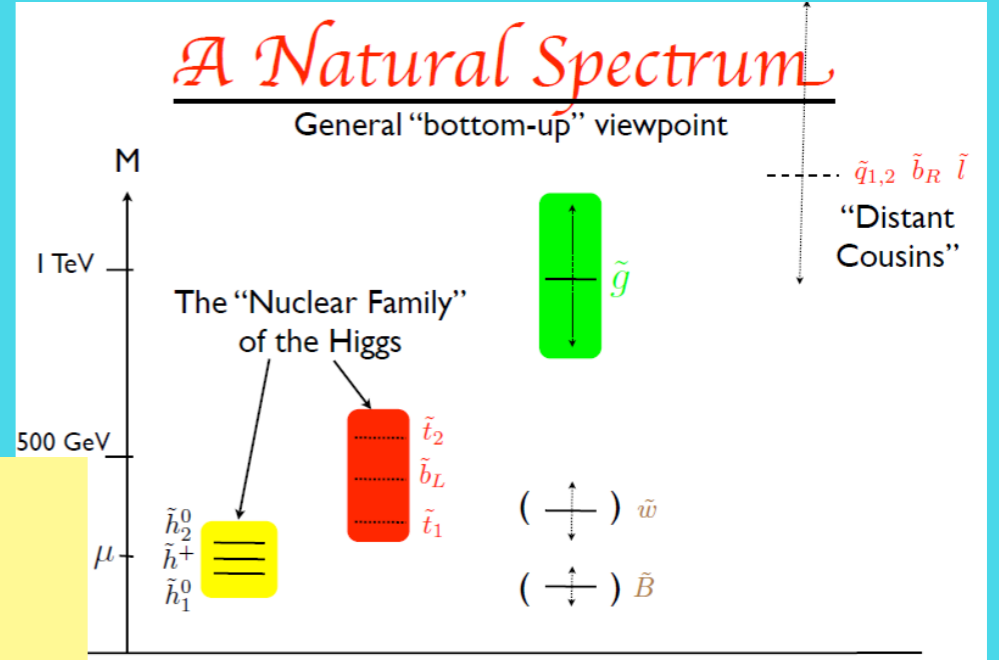

Weakly interacting particles

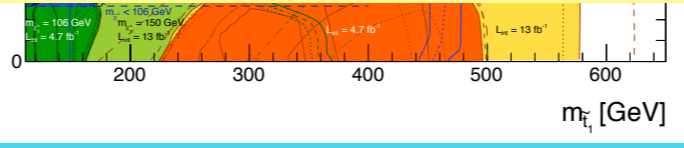
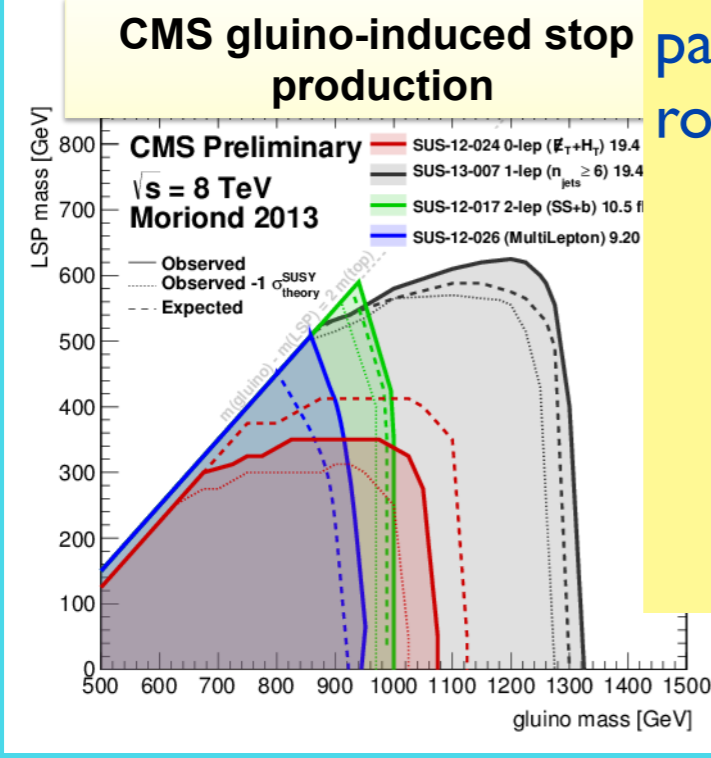

Tremendous progress of the LHC on SUSY searches is disappointing so far.

Looking in wrong place?

Still have not reached the the right mass interval?

Strongly interacting particles

Search for Supersymmetry @ LHC

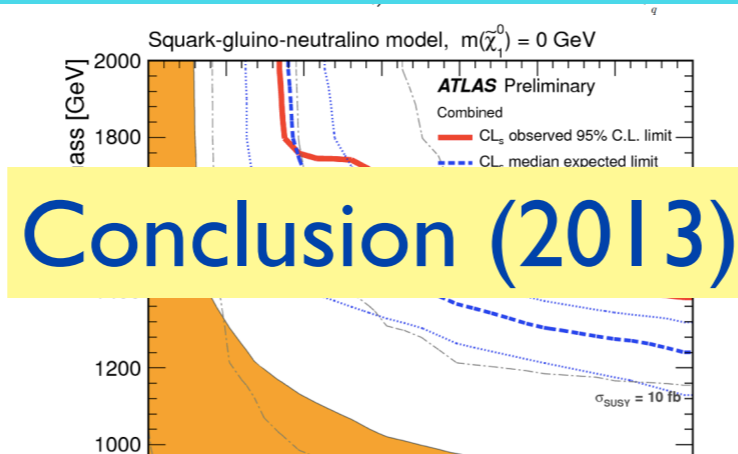
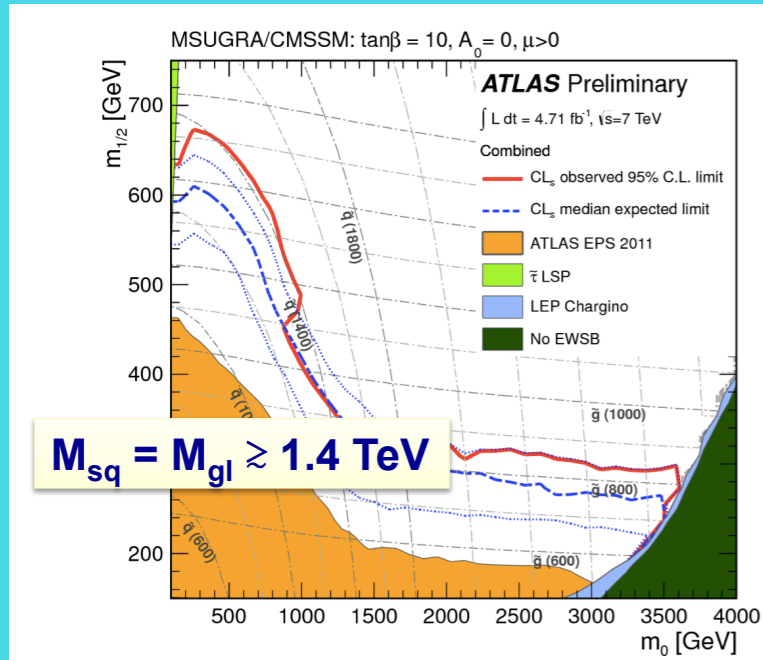

Conclusion (2013)

1. Still no sign of SUSY
2. The obtained constraints are model dependent
3. The models have many parameters and still there is large room for SUSY
4. It is possible that SUSY breaking is realised differently

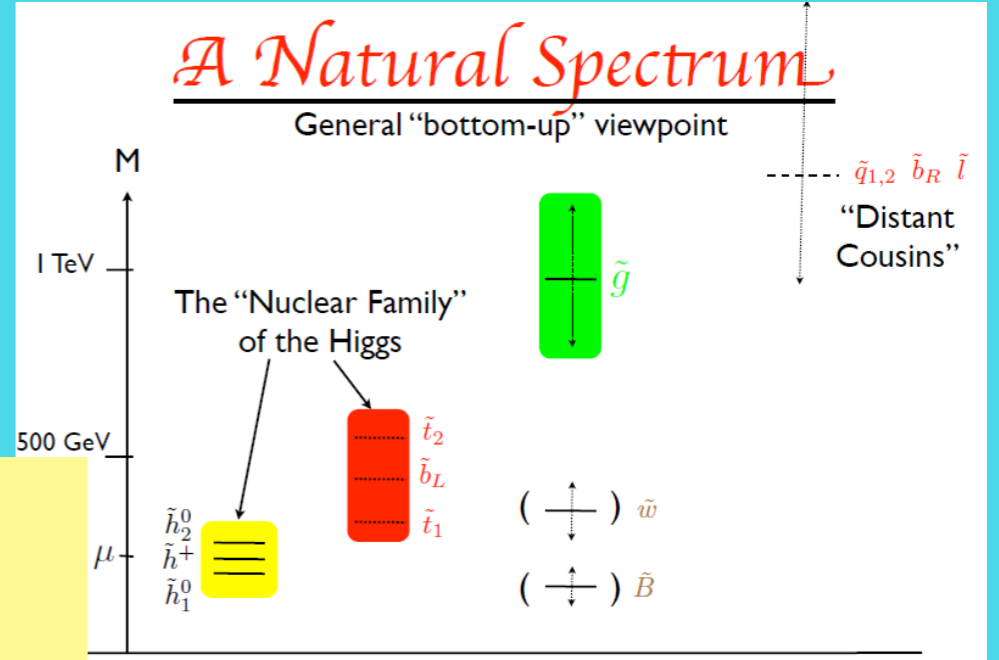

Weakly interacting particles

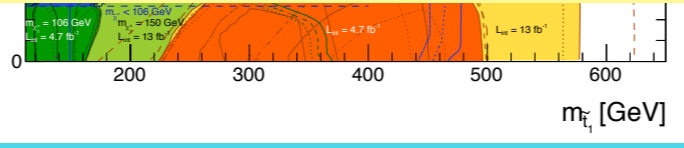
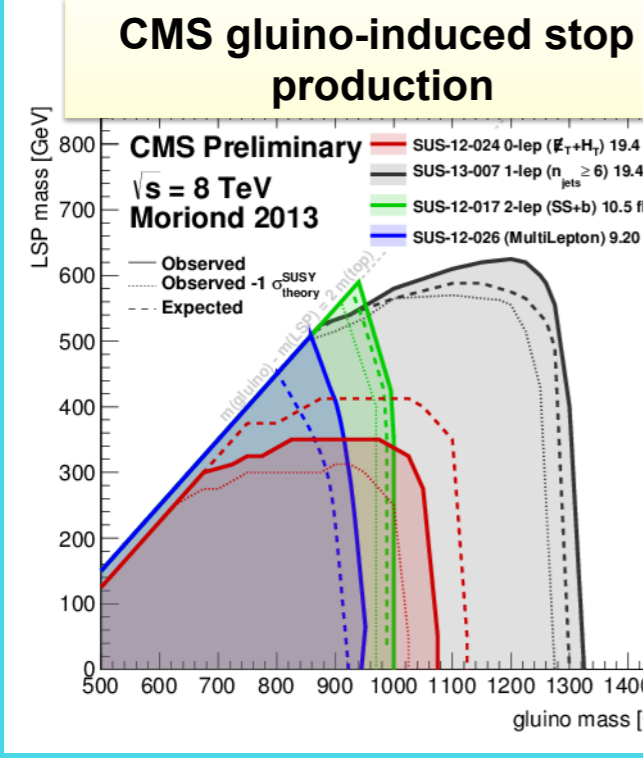

Strongly interacting particles

Tremendous progress of the LHC on SUSY searches is disappointing so far.

Looking in wrong place?

Still have not reached the the right mass interval?

Search for Supersymmetry @ LHC

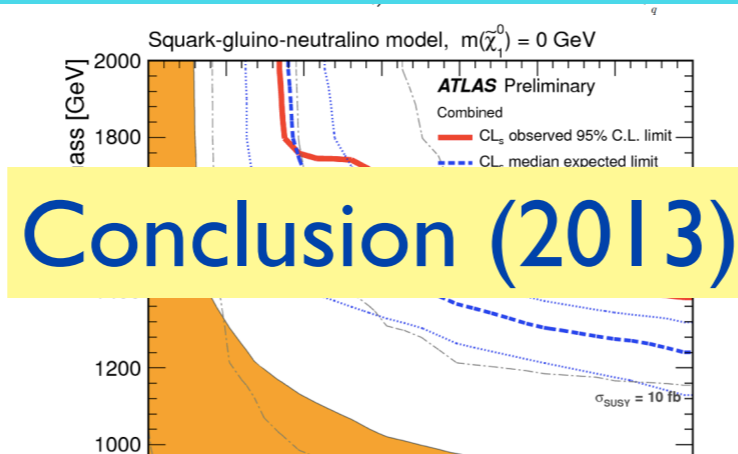
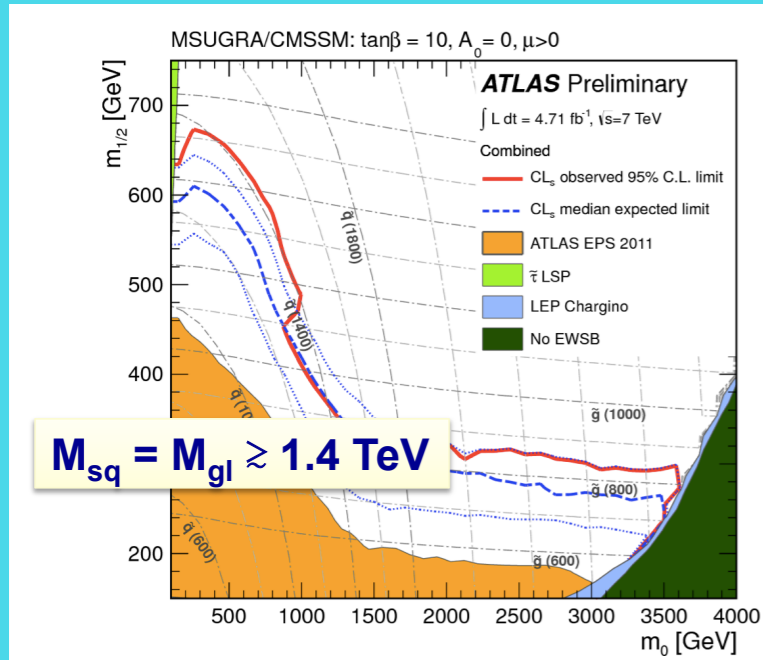

Conclusion (2013)

1. Still no sign of SUSY
2. The obtained constraints are model dependent
3. The models have many parameters and still there is large room for SUSY
4. It is possible that SUSY breaking is realised differently
5. The future run of the accelerator at maximal energy of 14 TeV in 2015-2016 might be crucial for low energy SUSY

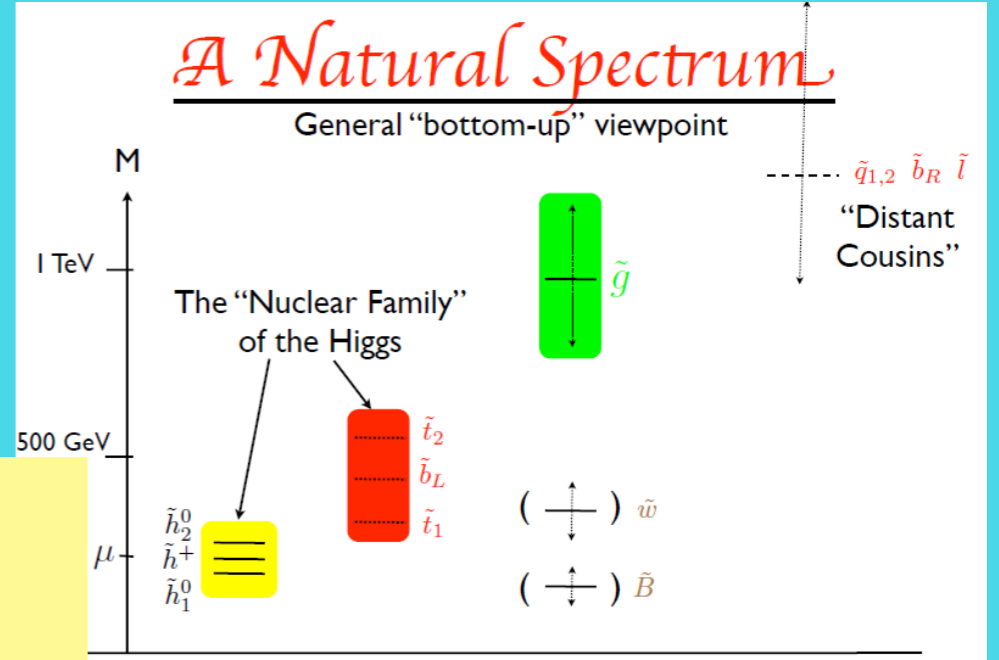

Weakly interacting particles

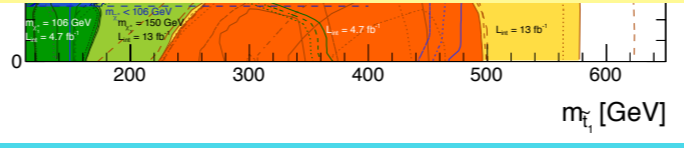
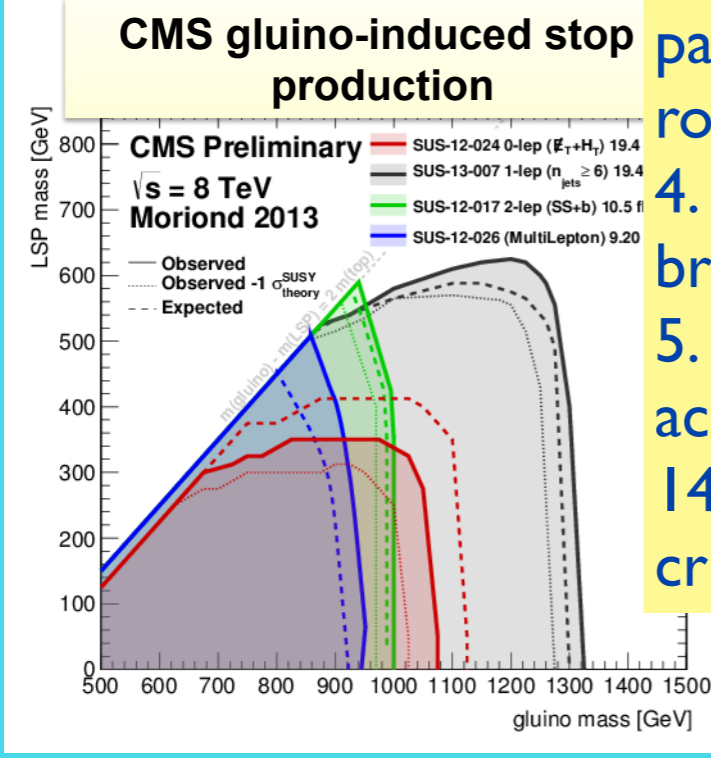

Strongly interacting particles

Tremendous progress of the LHC on SUSY searches is disappointing so far.

Looking in wrong place?

Still have not reached the the right mass interval?

Forward into the Future

Forward into the Future

The research program for the coming years

Forward into the Future

The research program for the coming years

I. The study of the properties of the **new scalar particle** with maximal possible precision

Forward into the Future

The research program for the coming years

1. The study of the properties of the **new scalar particle** with maximal possible precision
2. The search for any possible **deviations from the SM** indicating to existence of a new physics

Forward into the Future

The research program for the coming years

1. The study of the properties of the **new scalar particle** with maximal possible precision
2. The search for any possible **deviations from the SM** indicating to existence of a new physics
3. Direct search for **new physics** at TeV scale

Forward into the Future

The research program for the coming years

1. The study of the properties of the **new scalar particle** with maximal possible precision
2. The search for any possible **deviations from the SM** indicating to existence of a new physics
3. Direct search for **new physics** at TeV scale

The fulfilment of this program might require the construction of a new **electron-positron** collider in addition to existing hadron collider.

Forward into the Future

The research program for the coming years

1. The study of the properties of the **new scalar particle** with maximal possible precision
2. The search for any possible **deviations from the SM** indicating to existence of a new physics
3. Direct search for **new physics** at TeV scale

The fulfilment of this program might require the construction of a new **electron-positron** collider in addition to existing hadron collider.

We live in exciting time and have a chance to unveil the mystery!